

Service Manual

Turntable System

SL-1200MK2

[M], [MC],

[E], [EK], [XL], [EG], [EB], [EH],

[EF], [Ei], [XA], [PA], [PE], [PC]

SL-1210MK2

[E], [EG], [EH]

Supplement



*SL-1200MK2 is the model for silver type.

*SL-1210MK2 is the model for black type of SL-1200MK2.

Areas

- * [M] is available in the U.S.A.
- * [MC] is available in Canada.
- * [E] is available in Switzerland and Scandinavia.
- * [EK] is available in United Kingdom.
- * [XL] is available in Australia.
- * [EG] is available in F.R. Germany.
- * [EB] is available in Belgium.
- * [EH] is available in Holland.
- * [EF] is available in France.
- * [Ei] is available in Italy.
- * [XA] is available in Southeast Asia, Oceania, Africa, Middle Near East and Central South America.
- * [PA] is available in far East PX.
- * [PE] is available in European Military.
- * [PC] is available in European Audio Club.

Please use this manual together with the service manual for Model No. SL-1200MK2/1210MK2.

English

Inclusive SM & Changes

Specifications

Specifications are subject to change without notice for further improvement.
Weight and dimensions shown are approximate.

■ General

Power supply:	120V, AC 60 Hz (For [M], [MC] areas) ~110-120/220-240V, 50 or 60 Hz (For other areas)
Power consumption:	14 W (For [M], [MC] areas) 13.5 W (For other areas)
Dimensions: (W x H x D)	45.3 x 16.2 x 36 cm (17-27/32" x 6-19/64" x 14-11/64")
Weight:	12.5 kg (27.6 lb)

Turntable section

Type:	Quartz direct drive Manual turntable
Drive method:	Direct drive
Motor:	Brushless DC motor

Turntable platter:	Aluminum diecast Diameter 33.2 cm (13-5/64") Weight 2 kg (4.4 lb)
Turntable speeds:	33-1/3 rpm and 45 rpm
Starting torque:	1.5 kg · cm (1.3 lb · in)
Build-up characteristics:	0.7 s. from standstill to 33-1/3 rpm
Braking system:	Electronic brake
Wow and flutter:	0.01% WRMS* 0.025% WRMS (JIS C5521) ± 0.035% peak (IEC 98A Weighted)

* This rating refers to turntable assembly alone, excluding effects of record, cartridge or tonearm, but including platter.
Measured by obtaining signal from built-in frequency generator of motor assembly.

Rumble:	-56 dB (IEC 98A Unweighted) -78 dB (IEC 98A Weighted)
----------------	--

Matsushita Engineering and Service Company
50 Meadowland Parkway,
Secaucus, New Jersey 07094

Panasonic Hawaii Inc.
91-238 Kauhū St. Ewa Beach
P.O. Box 774
Honolulu, Hawaii 96808-0774

Matsushita Electric of Canada Limited
5770 Ambler Drive, Mississauga,
Ontario, L4W 2T3

Panasonic Sales Company,
Division of Matsushita Electric of Puerto Rico, Inc.
Ave. 65 De Infanteria, KM 9.7
Victoria Industrial Park
Carolina, Puerto Rico 00630

Technics

Panasonic Tokyo
Matsushita Electric Industrial Co., Ltd.
1-2, 1-chome, Shibakoen, Minato-ku, Tokyo 105 Japan

Matsushita Electric Trading Co., Ltd.
P.O. Box 288, Central Osaka Japan

SL-1200MK2/1210MK2

■ Tonearm section

Type:	Universal
Effective length:	230 mm (9-1/16")
Arm height adjustment range:	0 – 6 mm
Overhang:	15 mm (19/32")
Effective mass:	12 g (without cartridge)
Offset angle:	22°
Friction:	Less than 7 mg (lateral, vertical)
Tracking error angle:	Within 2°32' (at the outer groove of 30 cm (12") record Within 0°32' (at the inner groove of 30 cm (12") record)

Stylus pressure adjustment range:	0 – 2.5 g
Applicable cartridge weight range:	6 – 10 g
(with auxiliary weight):	13.5 – 17.5 g (including headshell)
(with shell weight):	9.5 – 13 g
	17 – 20.5 g (including headshell)
	3.5 – 6.5 g
	11 – 14 g (including headshell)
Headshell weight:	7.5 g

Notes

- ★ To improve the performance of SL-1200MK2/1210MK2, the bottom structure and circuit are changed in the course of production.
- ★ After the change, SL1200MK2-A/1210MK2-A is indicated in the name plate as the model of the set. It is discriminated from before-change set by -A. Also, check that the present change is of the sets after the change mark **D** shown in the serial No. sheet attached to the bottom and carton box.
- ★ This supplement service manual contains the bottom plate disassembly procedure, change part No., circuit diagram, P.C.B. and block diagrams. The other contents are the same as for the service manual of SL-1200MK2/1210MK2 already issued.
- ★ Sets with cartridge (EPC-207C) are included in those for same areas.
- ★ Since the power transformer fitting method is different for sets with serial number sheet change mark **E**, refer to the development plan on page 8.

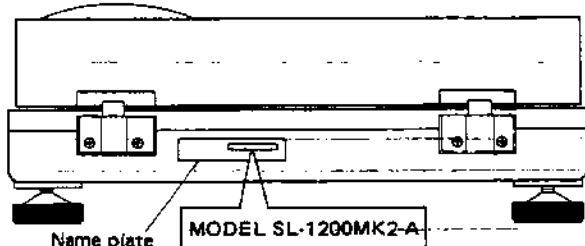

Serial No. sheet

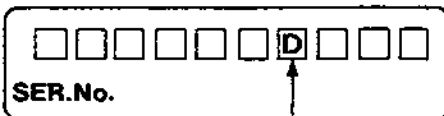

Change mark

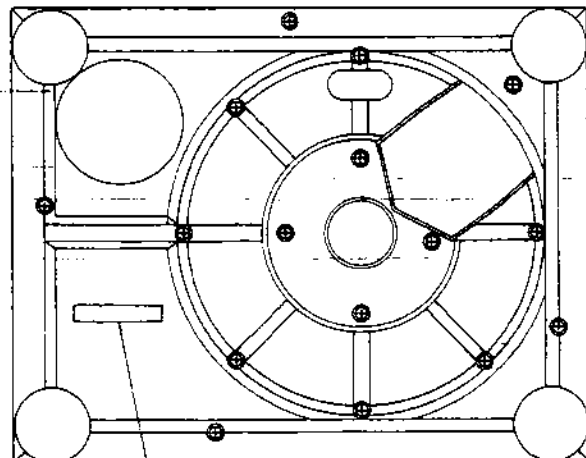

Serial No. sheet

Deutsch

TECHNISCHE DATEN

Änderungen der technischen Daten vorbehalten.
Die angegebenen Gewichts- und Abmessungsdaten sind ungefähre Werte.

■ Allgemeine Daten

Stromversorgung:	~110-120/220-240 V, 50/60 Hz Wechselstrom
Leistungsaufnahme:	13,5 W
Abmessungen: (B x H x T):	45,3 x 16,2 x 36 cm
Gewicht:	12,5 kg

■ Plattenspieler

Typ:	Manueller Quarz-Direktantrieb- Plattenspieler
Antrieb:	Direktantrieb
Motor:	Kollektorloser Gleichstrommotor
Plattenteller:	Aluminium-Spritzguß Durchmesser 33,2 cm Gewicht 2 kg

Plattenteller-Drehzahlen:	33-1/3 und 45 U/min
Aniandrehmoment:	1,5 kg · cm
Drehzahl-Hochlaufzeit:	0,7 s. vom Stillstand auf 33-1/3 U/min
Bremssystem:	Elektronische Bremse
Gleichlaufschwankungen:	0,01% WRMS* 0,025% WRMS (JIS C5521) ± 0,035% Spitze (IEC 98A bewertet)

* Diese Nennleistung bezieht sich auf das Laufwerk-Bauteil allein, ausschließlich Einflüsse von Schallplatte, Tonabnehmer oder Tonarm, aber einschließlich Plattenteller. Gemessen anhand von Signalen vom eingebauten Frequenzgenerator des Motorbauteils.

Rumpel-Geräuschspannungsabstand:	-56 dB (IEC 98A unbewertet) -78 dB (IEC 98A bewertet)
----------------------------------	--

■ Tonarm

Typ:	Universal-Tonarm	Auflagekraft- Einstellbereich:	0 – 2,5 g
Effektive Länge:	230 mm	Zulässiger Tonabnehmer- Gewichtbereich:	6 – 10 g
Tonarmhöhe- Einstellbereich:	0 – 6 mm		13,5 – 17 g (einschließlich Tonarmkopf)
Überhang:	15 mm	(mit Zusatz- Gegengewicht):	9,5 – 13 g
Effektive Masse:	12 g (ohne Tonabnehmer)		17 – 20,5 g (einschließlich Tonarmkopf)
Spurfehlwinkel:	2°32' bei der Einlaufrille einer 30 cm-Platte	Gewichtbereich: (mit Zusatzgewicht)	3,5 – 6,5 g
	0°32' bei der Auslaufrille einer 30 cm-Platte	Tonarmkopf-Gewicht:	7,5 g
Kröpfungswinkel:	22°		
Lagerreibung:	Weniger als 7 mg (horizontal, vertikal)		

Français

CARACTERISTIQUES

Les spécifications sont susceptibles d'être modifiées sans préavis.
Le poids et les dimensions donnés sont approximatifs.

■ Généralités

Alimentation:	Alternatif 110-120/220-240 V, 50 ou 60 Hz
Consommation:	13,5 W
Dimensions: (L x H x P)	45,3 x 16,2 x 36 cm
Poids:	12,5 kg

■ Platine de lecture

Type:	Entaînement direct à quartz Platine manuelle
Système d'entraînement:	Entraînement direct
Moteur:	Moteur C.C. sans balai
Plateau de lecture:	Aluminium moulé sous pression Diamètre 33,2 cm Poids 2 kg
Vitesses de rotation:	33-1/3 et 45 t/p.m.
Couple de démarrage:	1,5 kg · cm
Caractéristiques d'augmentation:	0,7 s. (rotation de 90°) à 33-1/3 t/p.m.
Système de freinage:	Frein électronique
Pleurage et scintillement:	0,01% de valeur efficace* 0,025% de valeur efficace (JIS C5521) ± 0,35% de crête (IEC 98A Pondéré)

*Ce régime nominal se rapporte à l'ensemble du tournedisque seul, excluant les effets du disque, de la cellule pick-up ou de bras de lecture, mais comprenant le plateau.
Mesuré par l'obtention d'un signal provenant du générateur de fréquences incorporé de l'ensemble du moteur.

Roufflement:	-56 dB (IEC 98A Non pondéré)
	-78 dB (IEC 98A Pondéré)

■ Bras de lecture

Type:	Bras de lecture universel
Longueur effective:	230 mm
Portée du réglage de la hauteur de bras:	0 – 6 mm
Porte-à-faux:	15 mm
Massa réelle:	12 g (sans la cellule pick-up)
Angle d'erreur de piste:	En deçà de 2°32' au sillon extérieur d'un disque de 30 cm En deçà de 0°32' au sillon intérieur d'un disque de 30 cm
Angle de décalage:	22°
Frottement:	Moins de 7 mg (latéral et vertical)
Plage de réglage de la pression d'appui:	0 – 2,5 g
Gamme du poids de la cellule pick-up utilisable:	6 – 10 g 13,5 – 17,5 g (y compris la coque porte-cellule)
(avec contrepoids auxiliaire):	9,5 – 13 g 17 – 20,5 g (y compris la coque porte-cellule)
(avec contrepoids de la cellule):	3,5 – 6,5 g 11 – 14 g (y compris la coque porte-cellule)
Poids de la cellule:	7,5 g

ESPECIFICACIONES

Las especificaciones quedan sujetas a cambios sin aviso previo.
El peso y las dimensiones indicados son aproximados.

■ En general

Alimentación de corriente:	~110-120/220-240 V, 50 ó 60 Hz
Consumo de corriente:	13,5 W
Dimensiones: (Ancho x Alto x Prof.)	45,3 x 16,2 x 36 cm
Peso:	12,5 kg

■ Sección del plato giratorio

Tipo:	Plato giratorio manual de accionamiento directo por cuarzo
Método de accionamiento:	Accionamiento directo
Motor:	Motor de corriente continua sin escobillas
Platillo del plato giratorio:	Aluminio fundido Diámetro 33,2 cm Peso 2 kg.
Velocidades del plato giratorio:	33-1/3 y 45 rpm
Par motor de arranque:	1,5 kg · cm
Características de establecimiento:	0,7 s. (a partir de reposo) hasta 33-1/3 rpm
Sistema de frenado:	Freno electrónico
Ululaciones y trémolo:	0,01% WRMS* 0,025% WRMS (JIS C5521) ± 0,035% cresta (IEC 98A Ponderado)

*Estas características se refieren únicamente al conjunto del plato giratorio, con exclusión de los efectos provenientes del disco, cartucho o del brazo sonoro, incluyendo, empero, el platillo. La medida fue tomada por medio de la señal obtenida del generador de frecuencia incorporado del conjunto del motor.

Ruido de rodadura:	-56 dB (IEC 98A No Ponderado)
	-78 dB (IEC 98A Ponderado)

■ Sección del brazo sonoro

Tipo:	Brazo sonoro universal
Longitud efectiva:	230 mm
Radio de ajuste de altura del brazo:	0 - 6 mm
Parte saliente:	15 mm
Masa efectiva:	12 g. (sin cartucho)
Angulo de descentramiento:	22°
Fricción:	Menos de 7 mg. (en sentido lateral y vertical)
Angulo de error de seguimiento:	Inferior a 2°32' en el surco exterior de un disco de 30 cm Inferior a 0°32' en el surco interior de un disco de 30 cm
Radio de ajuste de la presión de la aguja:	0 a 2,5 g.
Radio de peso de cartucho utilizable:	6 a 10 g. 13,5 a 17,5 g. (incluyendo la cápsula de la cabeza)
(con contrapeso de balance de reserva):	9,5 a 13 g. 17 a 20,5 g. (incluyendo la cápsula de la cabeza)
(con contrapeso de la cápsula):	3,5 a 6,5 g. 11 a 14 g. (incluyendo la cápsula de la cabeza)
Peso de la cápsula de la cabeza:	7,5 g

CHANGES

■ DISASSEMBLY INSTRUCTIONS

● How to remove the bottom cover and bottom base.

1. Remove the turntable mat and turntable.
2. Turn over the body on a soft cloth taking care not to damage the dust cover.
3. Remove the insulators and the 21 setscrews (Fig. 1 : ①, ②, ③) of the bottom cover.
4. Remove the 6 setscrews (Fig. 2 : ④) of the bottom base.

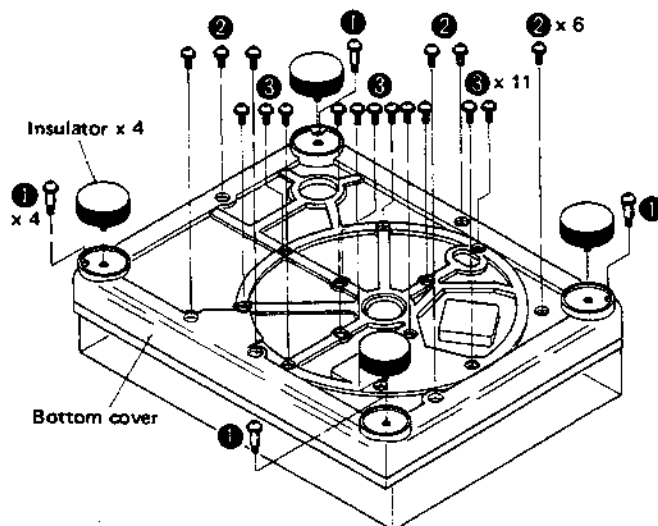

Fig. 1

Supplement

● How to remove the hinge case

1. Remove the bottom cover. (Refer to "How to remove the bottom cover".)
2. Remove the 4 setscrews (Fig. 2 : ⑤) of the hinge case bracket.
3. Remove the 4 setscrews (Fig. 2 : ⑥) of the hinge case.

Note: The other disassembly procedure are the same as for before-change sets.

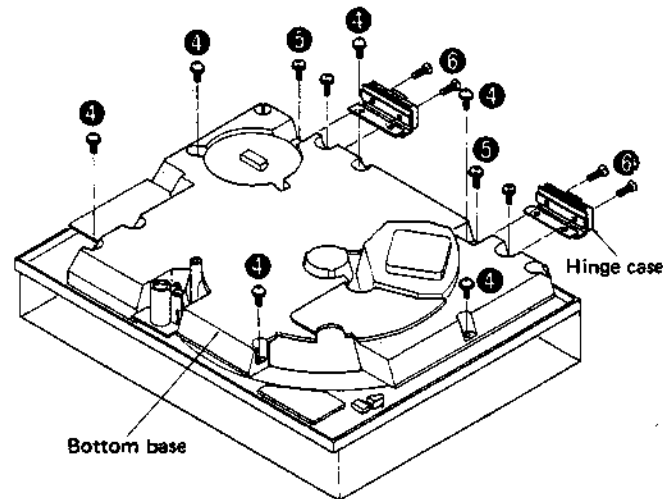

Fig. 2

■ REPLACEMENT PARTS LIST

Notes:

1. This parts list mentions only the difference between before and after change of SL-1200MK2/1210MK2.
2. Ⓚ-marked parts are used only for SL-1210MK2 (black type). And ○-marked parts are used for SL1200MK2 (silver type).
3. Parts other than Ⓚ- and ○-marked are used for both SL-1210MK2 and SL-1200MK2.
4. The "Ⓢ" mark is service standard parts and may differ from production parts.

Areas

- [M] is available in the U.S.A.
- [MC] is available in Canada.
- [E] is available in Switzerland and Scandinavia.
- [EK] is available in United Kingdom.
- [XL] is available in Australia.
- [EG] is available in F.R. Germany.
- [EB] is available in Belgium.
- [EH] is available in Holland.
- [EF] is available in France.
- [Ei] is available in Italy.
- [XA] is available in Southeast Asia, Oceania, Africa, Middle Near East and Central South America.
- [PA] is available in far East PX.
- [PE] is available in European Military.
- [PC] is available in European Audio Club.

Ref. No.	Change of Part No.		Part Name & Description	Per Set (Pcs.)	Remarks
	SL-1200MK2 (Before Change)	SL-1200MK2/1210MK2 (After Change)			
INTEGRATED CIRCUIT					
IC302	SVITC4011BP	MN4011B	NAND Gate	1	
TRANSISTOR					
Q1	2SD389A-Q	2SD1265	Regulator	1	
DIODES					
D1	SVDS1RBA40	SVDS1RBA20Z	Rectifier	1	△
D201, 202	SVDSR-105C	SVDPR3902S-9	Speed Indicator	2	
D203 ~ 206	SVDEBR5505S	SVDSLH54VT3	Strobe	4	
D401	SVDGL-9PG2	SVDGL-9NG2	Pitch Indicator	1	
CRYSTAL					
X201	SVQU306115	SVQMS4193	4.193 MHz, Oscillator	1	
VARIABLE RESISTORS					
VR301	EVMH2GA00B53	EVMH1GA00B23	Pitch Control Adjustment, 2kΩ (B)	1	
VR303	EVB05C19ABE	SFDZ122N11	Pitch Control	1	
SWITCHES					
S203	SFDSS5GL13C	SFDSS01GL13	Start/Stop	1	
S601	SFDSS5GL13S	SFDSS5GL13P	Power	1	△
TRANSFORMER					
T1	SLT60EU7B	SLT66DTL3A [M]	Power Source	1	△
T1	SLT60E31C	SLT66DT14C [MC]	Power Source	1	△
T1	SLTF590D	SLT66DTE13A [Other areas]	Power Source	1	△

SL-1200MK2/1210MK2

Ref. No.	Change of Part No.		Part Name & Description	Per Set (Pcs.)	Remarks
	SL-1200MK2 (Before Change)	SL-1200MK2/1210MK2 (After Change)			
RESISTORS					
R4	ERD25FJ561	ERD25FJ471	Carbon, 1/4W, 470Ω	1	Ⓢ
R209	ERD25TJ154	ERD25TJ334	Carbon, 1/4W, 330kΩ	1	Ⓢ
R211	ERD25FJ103	ERD25FJ472	Carbon, 1/4W, 4.7kΩ	1	Ⓢ
R212	ERD25FJ121	ERD25FJ151	Carbon, 1/4W, 150Ω	1	Ⓢ
R222	Addition	ERD25FJ391	Carbon, 1/4W, 390Ω	1	Ⓢ
R301	ERO25CKF3301	ERO25CKF2701	Metal Film, 1/4W, 2.7kΩ	1	Ⓢ
R304	ERD25FJ152	ERD25FJ561	Carbon, 1/4W, 560Ω	1	Ⓢ
R401	Addition	ERD50FJ152	Carbon, 1/2W, 1.5kΩ	1	Ⓢ
R601	ERD25FJ4R7	ERD50FJ4R7	Carbon, 1/2W, 4.7Ω	1	△ Ⓢ
CAPACITORS					
C5, 6	Addition	ECQM1223KZ	Polyester, 125V, 0.022μF	1	△
C104 ~ 107	ECQM1H104KZ	ECQM1H104JZ	Polyester, 50V, 0.1μF	4	Ⓢ
C109, 110	ECQM1H104KZ	ECQM1H104JZ	Polyester, 50V, 0.1μF	2	Ⓢ
C111	ECQM1H562KZ	ECQM1H562JZ	Polyester, 50V, 0.0056μF	1	Ⓢ
C204	ECQM1H473KZ	ECQM1H473JZ	Polyester, 50V, 0.047μF	1	Ⓢ
C210	ECQM1H224KZ	ECQM1H224JZ	Polyester, 50V, 0.22μF	1	Ⓢ
C211	ECQM1H473KZ	ECQM1H473JZ	Polyester, 50V, 0.047μF	1	Ⓢ
C217 ~ 219	Addition	ECKD1H104ZF	Ceramic, 50V, 0.1μF	1	Ⓢ
C301	ECQK1123FZ	ECQK1333GZ	Polyester, 125V, 0.033μF	1	
C302	ECQK1123FZ	ECQK1682GZ	Polyester, 125V, 0.0068μF	1	
C305	ECQM1H122KZ	ECQM1H122JZ	Polyester, 50V, 0.0012μF	1	Ⓢ
CABINET and CHASSIS PARTS					
9	SFUP122-12	Deletion	-----	0	
10	SFAC122-01	SFAC122-01	Cabinet (Silver)	1	○
		SFAC124S01	Cabinet (Black)	1	Ⓚ
25	SFXB122-02	SFXB122-06	Boss, Drive	1	
33	SFQA001-02	SFQA122-03	Spring	1	
36	SFUP025-01	SFUP122-16 [M, MC, PA, PE, PC]	Bracket, AC Cord	1	
	SFUP025X01	SFUP122X01 [Other areas]	Bracket, AC cord	1	
38	SFUP132-03	SFGC122-03	Cushion	2	
40	SFUP122-10	Deletion	-----	0	
42	SFKK122-03	SFKK122-03	Plate (Silver)	1	
		SFKK124S01	Plate (Black)	1	
48	SFAU122-01	SFAU122-02	Bottom Base	1	
48-1	Addition	SFAU122-03	Bottom Cover	1	
49	SFUP122-05	SFUP122-23	Supporter (A), Hinge	2	
50	SFUP122-04	SFUP122-24	Supporter (B), Hinge	2	
51	SFUM170-07	SFUMM02N04	Case, Hinge	2	
55	SFNN122M01	SFNN122M10 [M]	Name Plate	1	○
	SFNN122C01	SFNN122C10 [MC]	Name Plate	1	○
	SFNN122S01	SFNN122S10 [E]	Name Plate	1	○
	SFNN122L01	SFNN122G10 [EK, XL]	Name Plate	1	○
	SFNN122X01	SFNN122X10 [XA]	Name Plate	1	○
	Addition	SFNN122P10 [PA, PE]	Name Plate	1	○
	Addition	SFNN122P11 [PC]	Name Plate	1	○
	SFNN122N01	SFNN122N10 [Other areas]	Name Plate	1	○
	Addition	SFNN124S10 [E]	Name Plate	1	Ⓚ
Addition	SFNN124Q10 [EG, EH]	Name Plate	1	Ⓚ	
56	SFX0122-01	Deletion	-----	0	
57	SFX0122-02	Deletion	-----	0	
58	SFAT122-01A	SFATM02N01A	Hinge	1	

SL-1200MK2/1210MK2

Ref. No.	Change of Part No.		Part Name & Description	Per Set (Pcs.)	Remarks
	SL-1200MK2 (Before Change)	SL-1200MK2/1210MK2 (After Change)			
TO NEARM PARTS					
62	SFPAM18201K	SFPAM18201K	Tonearm Ass'y (Silver)	1	○
		SFPAM18202K	Tonearm Ass'y (Black)	1	Ⓚ
79	SFPKB17201S	SFPKB17204E	Ring, Arm Base Operation	1	
82	SFGK132-01	SFGK132-01	Cap (Silver)	1	○
		SFGK133S01	Cap (Black)	1	Ⓚ
ACCESSORIES					
A1	SFNU122M01	SFNU122M06 [M]	Instruction Book	1	
	SFNU122C01	SFNU122C06	Instruction Book	1	
	SFNU122S01	SFNU122S01 [E]	Instruction Book	1	
	SFNU122G01	SFNU122G01 [EK]	Instruction Book	1	
	Addition	SFNU122P01 [PA, PE, PC]	Instruction Book	1	
	SFNU122X01	SFNU122X01 [Other areas]	Instruction Book	1	
A2	SFWE010	SFWE122-01	45 Adaptor	1	
PACKING PARTS					
P1	SFHP122C01	SFHP122C02 [MC, EF]	Carton Box (Silver)	1	○
		SFHP122M02 [Other areas]	Carton Box (Silver)	1	○
	SFHP122M01	SFHP124S02	Carton Box (Black)	1	Ⓚ
P9	Addition	SPB1083	Polyethylene Bag, Accessories	2	
P10	Addition	SPJ15	Polyethylene Bag, Shell Weight	1	
P11	Addition	SFHZD03M01	Polyethylene Bag, Dust Cover	3	
P12	Addition	SFHZ122-01	Polyethylene Bag, 45 Adaptor	1	
P13	Addition	SPP189	Polyethylene Bag, Cords	2	

■ ADJUSTMENT POINTS

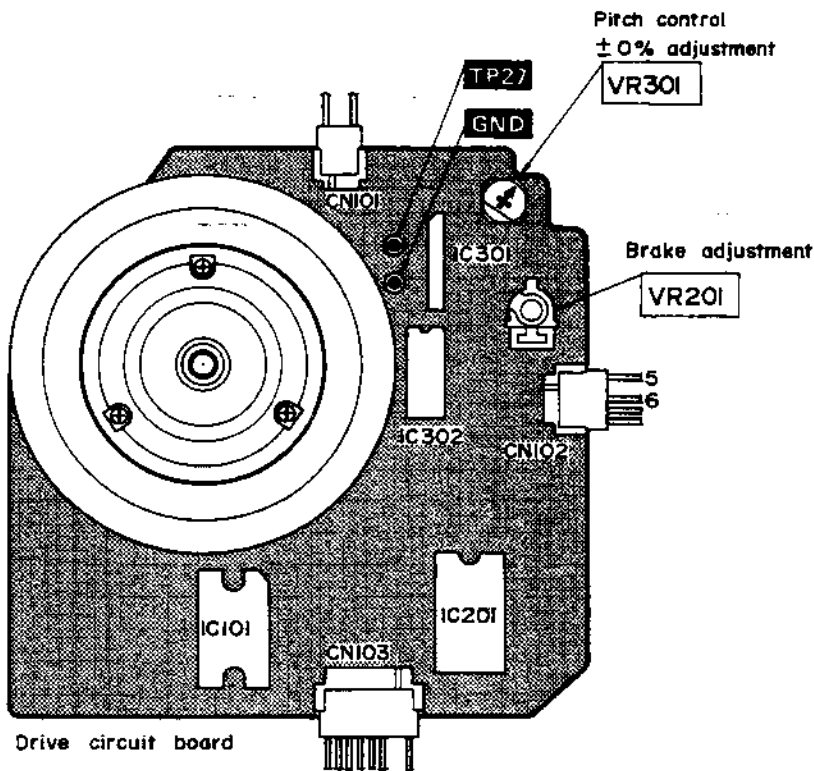

Fig. 3 (Abb. 3)

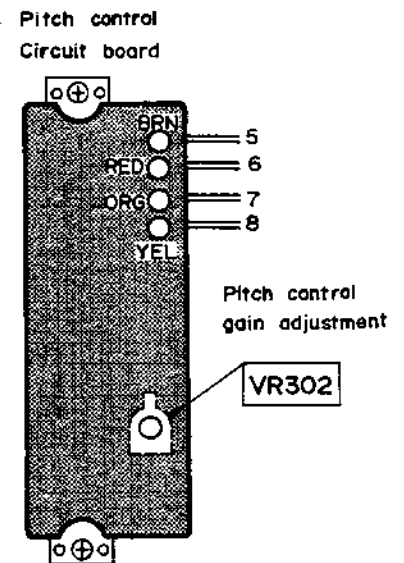

Fig. 4 (Abb. 4)

MEASUREMENTS AND ADJUSTMENTS English

• Conditions of set, and instruments used

1. Remove the panel cover.
2. Remove the bottom cover (when adjusting the pitch control gain).
3. Frequency counter
4. Tester

	Adjustment	Connection	Parts adjusted	Procedure
1	Pitch control $\pm 0\%$ adjustment	Frequency counter (+) – TP27 (–) – Earth point	VR301 (Fig. 3)	<ol style="list-style-type: none"> 1. Connect the frequency counter and turn the power supply ON. 2. Set the pitch control knob to "0". (Indicator lights up.) 3. Adjust VR301 so that the frequency is 262.08 kHz \pm 0.05 kHz.
2	Pitch control gain adjustment	Tester (+) – CN102 terminal ⑤ (–) – CN102 terminal ⑥	VR302 (Fig. 4)	<ol style="list-style-type: none"> 1. Set the pitch control knob to "0". 2. Pull out the connector CN102 of drive P.C.B. 3. Connect the tester to terminals ⑤ and ⑥ of connector CN102 on the pitch control P.C.B. side. 4. Adjust VR302 so that the resistance value of the tester is 2.7 kΩ \pm 0.1 kΩ.
3	Brake adjustment	_____	VR201 (Fig. 3)	<ol style="list-style-type: none"> 1. Adjust VR201 so that the rotation at 33 r.p.m. stops within the angle of 90° ~ 120° after depressing the stop button.

MESSUNGEN UND JUSTIERUNGEN Deutsch

• Zustand des Gerätes und zu verwendende Instrumente

1. Die Abdeckplatte entfernen.
2. Die Bodenabdeckung entfernen (wenn die Drehzahlregelungs-Verstärkung justiert werden soll).
3. Frequenzzähler
4. Prüfgerät

	Justierung	Anschlüsse	Zu justie- render Teile	Vorgehen
1	$\pm 0\%$ -Justierung des Drehzahlreglers	Frequenzzähler (+) – TP27 (–) – Massepunkt	VR301 (Abb. 3)	<ol style="list-style-type: none"> 1. Frequenzzähler anschließen und Netzschalter einschalten. 2. Drehzahlreglerknopf auf "0" stellen. (Anzeige leuchtet auf.) 3. VR301 so justieren, daß die Frequenz 262,08 kHz \pm 0,05 kHz beträgt.
2	Justierung der Drehzahlregelungs-Verstärkung	Prüfgerät (+) – CN102 Anschluß ⑤ (–) – CN102 Anschluß ⑥	VR302 (Abb. 4)	<ol style="list-style-type: none"> 1. Den Drehzahlreglerknopf auf "0" einstellen. 2. Steckverbindung CN102 von der Antriebsplatine herausziehen. 3. Prüfgerät an Anschlüsse ⑤ und ⑥ der Steckverbindung CN102 auf der Drehzahlreglerseite der Platine anschließen. 4. VR302 so justieren, daß der Widerstandswert des Prüfgerätes 2,7 kΩ \pm 0,1 kΩ beträgt.
3	Bremsjustierung	_____	VR201 (Abb. 3)	<ol style="list-style-type: none"> 1. VR201 so justieren, daß die Rotation bei 33 UPM innerhalb 90° ~ 120° nach Drücken der Stop-Taste stoppt.

MESURAGES ET RÉGLAGES

Français

• Conditions de l'appareil et appareils utilisés.

1. Retirer le panneau de protection.
2. Retirer le panneau de protection inférieur (lors de l'ajustement de l'amplification du réglage d'écart).
3. Compteur de fréquence
4. Appareil contrôleur

	Mise au point	Raccordement	Elements à régler	Marche à suivre
1	Ajustement de $\pm 0\%$ du réglage d'écart	Compteur de fréquence (+) – TP27 (–) – Point de contact à la terre	VR301 (Fig. 3)	<ol style="list-style-type: none"> 1. Raccorder le compteur de fréquence et mettre en marche l'alimentation. 2. Régler le bouton du réglage d'écart sur "0". (L'indicateur s'éclairera.) 3. Ajuster VR301 de telle sorte que la fréquence soit de $262,08 \text{ kHz} \pm 0,05 \text{ kHz}$.
2	Ajustement de l'amplification du réglage d'écart	Appareil contrôleur (+) – Borne CN102 ⑤ (–) – Borne CN102 ⑥	VR302 (Fig. 4)	<ol style="list-style-type: none"> 1. Régler le bouton de réglage d'écart sur "0". 2. Retirer le connecteur CN102 de la plaquette à circuits imprimés de commande. 3. Raccorder l'appareil contrôleur aux bornes ⑤ et ⑥ du connecteur CN102 sur le côté de la plaquette à circuits imprimés du réglage d'écart. 4. Ajuster VR302 de telle sorte que la valeur de résistance de l'appareil contrôleur soit de $2,7 \text{ k}\Omega \pm 0,1 \text{ k}\Omega$.
3	Ajustement du frein	_____	VR201 (Fig. 3)	<ol style="list-style-type: none"> 1. Régler VR201 de telle sorte que la rotation à 33 t/p.m. s'arrête en deçà d'un angle de $90^\circ \sim 120^\circ$ après avoir appuyé sur la touche d'arrêt.

MEDICIONES Y AJUSTE

Español

• Condiciones de aparato e instrumentos usados

1. Remover la cubierta del panel.
2. Remover la cubierta inferior (al ajustar la ganancia de control de altura de los sonidos).
3. Contador de frecuencia
4. Probador

	Ajuste	Conexión	Piezas ajustadas	Procedimiento
1	Ajuste $\pm 0\%$ de control de altura	Contador de frecuencia (+) – TP27 (–) – Punto de tierra	VR301 (Fig. 3)	<ol style="list-style-type: none"> 1. Conectar el contador de frecuencia y prender la fuente de alimentación. 2. Ajustar la perilla de control de altura de sonidos a "0". (El indicador se ilumina.) 3. Ajustar VR301 de manera que la frecuencia sea $262,08 \text{ kHz} \pm 0,05 \text{ kHz}$.
2	Ajuste de ganancia de control de altura	Probador (+) – Terminal de CN102 ⑤ (–) – Terminal de CN102 ⑥	VR302 (Fig. 4)	<ol style="list-style-type: none"> 1. Poner el control de altura de sonidos en "0". 2. Sacar el conector CN102 de T.C.I. de accionamiento. 3. Conectar el probador a terminales ⑤ y ⑥ de conector CN102 del lado de T.C.I. de control de altura. 4. Ajustar VR302 de manera que el valor de resistencia del probador sea $2,7 \text{ k}\Omega \pm 0,1 \text{ k}\Omega$.
3	Ajuste de freno	_____	VR201 (Fig. 3)	<ol style="list-style-type: none"> 1. Ajustar VR201 de manera que la rotación a 33 r.p.m. se pare dentro del ángulo de $90^\circ \sim 120^\circ$ después oprimir el botón de parada

RESISTORS AND CAPACITORS

- Notes:**
- Part numbers are indicated on most mechanical parts. Please use this part number for parts orders.
 - Important safety notice: Components identified by Δ mark have special characteristics important for safety. When replacing any of these components use only manufacturer's specified parts.
 - The "S" mark is service standard parts and may differ from production parts.
 - Bracketed indications in Ref. No. column specify the area. Parts without these indications can be used for all area.
 - The unit of resistance is Ω (ohm).
K = 1000 Ω , M = 1000k Ω
 - The unit capacitance is μ F (microfarad).
P = 10⁻⁶ μ F

Areas

- * [M] is available in the U.S.A.
- * [MC] is available in Canada.
- * [E] is available in Switzerland and Scandinavia.
- * [EK] is available in United Kingdom.
- * [XL] is available in Australia.
- * [EG] is available in F.R. Germany.
- * [EB] is available in Belgium.
- * [EH] is available in Holland.
- * [EF] is available in France.
- * [Ei] is available in Italy.
- * [XA] is available in Southeast Asia, Oceania, Africa, Middle Near East and Central South America.
- * [PA] is available in far East PX.
- * [PE] is available in European Military.
- * [PC] is available in European Audio Club.

Numbering System of Resistor

Example

ERD	25	F	J	101
Type	Wattage	Shape	Tolerance	Value
ERX	2	AN	J	2R2
Type	Wattage	Shape	Tolerance	Value

Numbering System of Capacitor

Example

ECKD	1H	102	Z	F
Type	Voltage	Value	Tolerance	Peculiarity
ECEA	50	M	R47	R
Type	Voltage	Peculiarity use	Value	Special use

Resistor type	Wattage	Tolerance
ERD: Carbon	25 : 1/4W	F : \pm 1%
ERG: Metal Oxide	50 : 1/2W	J : \pm 5%
ERO: Metal Film	1A : 1W	
ERX: Metal Film	2A : 2W	

Capacitor Type	Voltage	Tolerance
ECEA : Electrolytic	OJ : 6.3V	J : \pm 5%
ECEB : Electrolytic	1C : 16V	K : \pm 5%
ECCD : Ceramic	1E : 25V	M : \pm 20%
ECQM : Polyester	1H : 50V	Z : +80%, -20%
ECQU : Polyester	1 : 100V	
ECQF : Polyester	1A : 125V	
ECNC : Polyester	4A : 400V	

Ref. No.	Part No.	Value	Ref. No.	Part No.	Value	Ref. No.	Part No.	Value	Ref. No.	Part No.	Value
RESISTORS			R210	ERD25TJ183	18K	CAPACITORS			C210	ECQM1H224JZ	0.22
R1	ERD25FJ562	5.6K	R211	ERD25FJ472	4.7K	C1	ECEB1HU471	470	C211	ECQM1H473JZ	0.047
R2	ERD25FJ682	6.8K	R212	ERD25FJ151	150	C2	ECEA1EU330	33	C212	ECEA1HU3R3	3.3
R3	ERD25FJ272	2.7K	R213	ERD25FJ122	1.2K	C3	ECEA1EU220	22	C213	ECOD1H471K	470P
R4,5	ERD25FJ471	470	R214	ERD25TJ223	22K	C5,6	ECQM1223KZ	0.022	C214	ECEA1CU101	100
R101	ERD25FJ103	10K	R215	ERD25FJ472	4.7K	C101,102	ECEA1EU330	33	C215	ECEA1HU010	1
R102	ERX1ANJ4R7	4.7	R216	ERD25TJ154	150K	C103	ECEA1EU330	33	C216	ECEA1CU470	47
R103	ERD25FJ472	4.7K	R217	ERD25TJ223	22K	C104,105	ECQM1H104JZ	0.1	C217,218	ECKD1H104ZF	0.1
R104	ERD25TJ473	47K	R218	ERD25FJ102	1K	C106,107	ECQM1H104JZ	0.1	C219	ECKD1H104ZF	0.1
R105	ERD25FJ103	10K	R219	ERD25FJ332	3.3K	C108	ECEA1EU101	100	C301	ECQK1333GZ	0.033
R106	ERD25FJ150	15	R220	ERD25FJ221	220	C109,110	ECQM1H104JZ	0.1	C302	ECQK1682GZ	0.0068
R107	ERX1ANJ1R5	1.5	R221	ERD25FJ471	470	C111	ECQM1H562JZ	0.0056	C303	ECEA1HU010	1
R108	ERD25FJ103	10K	R222	ERD25FJ391	390	C112	ECEA1HU4R7	4.7	C304	ECEA1CU100	10
R109,110	ERX1ANJ4R7	4.7	R301	ERD25CKF2701	2.7K	C201	ECEA1CU330	33	C305	ECQM1H122JZ	0.0012
R201	ERG1ANJ561	560	R302	ERD25FJ471	470	C202,203	ECEA1HU010	1	C306	ECEA1HU010	1
R202	ERD25FJ103	10K	R303	ERD25FJ822	8.2K	C204	ECQM1H473JZ	0.047	C801(M)	ECQF1A473MD	0.047
R203	ERD25FJ470	47	R304	ERD25FJ561	560	C205	ECEA0JU221	220	C801(MC)	ECQU1A47ME	0.047
R204	ERD25FJ272	2.7K	R305	ERD25FJ181	180	C206	ECEA1HU010	1	C801(Other areas)	ECNC4A473M	0.047
R205	ERD25TJ124	120K	R306	ERD25TJ223	22K	C207	ECOD1H101K	100P			
R206	ERD25TJ183	18K	R307	ERD25FJ272	2.7K	C208	ECOD1H220K	22P			
R207	ERD25TJ563	56K	R401	ERD50FJ152	1.5K	C209	ECEA1CU101	100			
R208	ERD25TJ224	220K	R601	ERD50FJ4R7	4.7						
R209	ERD25TJ334	330K									

REPLACEMENT PARTS LIST

- Notes:**
1. Part numbers are indicated on most mechanical parts. Please use this part number for parts orders.
 2. Important safety notice:
Components identified by Δ mark have special characteristics important for safety. When replacing any of these components use only manufacturer's specified parts.
 3. Bracketed indications in Ref. No. columns specify the area. Parts without these indications can be used for all areas.
 4. The "S" mark is service standard parts and may differ from production parts.
 5. The parenthesized numbers in the column of description stand for the quantity per set.
 6. $\text{\textcircled{K}}$ -marked parts are used only for SL-1210MK2 (black type). And $\text{\textcircled{O}}$ -marked parts are used for SL-1200MK2 (silver type).
 7. Parts other than $\text{\textcircled{K}}$ - and $\text{\textcircled{O}}$ -marked are used for both SL-1210MK2 and SL-1200MK2.

Areas

- * [M] is available in the U.S.A.
- * [MC] is available in Canada.
- * [E] is available in Switzerland and Scandinavia.
- * [EK] is available in United Kingdom.
- * [XL] is available in Australia.
- * [EG] is available in F.R. Germany.
- * [EB] is available in Belgium.
- * [EH] is available in Holland.
- * [EF] is available in France.
- * [Ei] is available in Italy.
- * [XA] is available in Southeast Asia, Oceania, Africa, Middle Near East and Central South America.
- * [PA] is available in far East PX.
- * [PE] is available in European Military.
- * [PC] is available in European Audio Club.

Ref. No.	Part No.	Description	Ref. No.	Part No.	Description	Ref. No.	Part No.	Description
INTEGRATED CIRCUITS			CRYSTAL			LAMP		
IC101	AN6675	Turntable Drive	X201	SVQMS4193	4.193MHz Oscillator	PL1	Δ SFDN122-01	Stylus Illuminator
IC201	AN6680	Turntable Control	VARIABLE RESISTORS			TRANSFORMER		
IC301	AN6682	Pitch Control	VR201	$\text{\textcircled{S}}$ EVTS3MA00B54	Brake Adjustment, 50k Ω (B)	T1(M)	Δ SLT66DTL3A	Power Source
IC302	MN4011B	NAND Gate	VR301	EVMH1GA00B23	Pitch Control $\pm 0\%$ Adjustment, 2k Ω (B)	T1(MC)	Δ SLT66DT14C	Power Source
TRANSISTORS			VR302	$\text{\textcircled{S}}$ EVTS3MA00B54	Pitch Control Gain Adjustment, 50k Ω (B)	T1(Other areas)	Δ SLT66DTE13E	Power Source
Q1	2SD1265	Regulator	VR303	SFDZ122N11	Pitch Control	FUSES		
Q2,3	2SD637	Regulator	SWITCHES			F1(MC)	Δ XBA1F12NU14	125V, 1.2A
Q201	$\text{\textcircled{S}}$ 2SC1846-R	Regulator	S201,202	EVQP5R04K	Speed Selector	F1 Except for (M,MC)	Δ XBA2C025T1A	250V, 250mA
Q202	2SD637	LED Driver	S203	SFDSS01GL13	Start/Stop	F2 Except for (M,MC)	Δ XBA2C10TR0	250V, 11A
Q203	$\text{\textcircled{S}}$ 2SC1328-T	FG Amp.	S401	SFDS2M5L-C	Stylus-Illuminator			
DIODES			S601	Δ SFDSS5GL13P	Power			
D1	Δ SVDS1RBA20Z	Rectifier	S602 Except for (M,MC)	Δ SFDSHXW01317	Voltage Selector			
D2	MA1051	5.1V Zener						
D201,202	SVDPR3902S-9	Speed Indicator						
D203~206	SVDSLH54VT3	Strobe						
D204A	MA162A	Switching						
D301	MA1051	5.1V Zener						
D401	SVDGL-9NG2	Pitch Indicator						

SL-1200MK2/1210MK2

Ref. No.	Part No.	Description	Ref. No.	Part No.	Description	Ref. No.	Part No.	Description
CHABINET AND CHASSIS PARTS								
1	SFAD122-01A	Dust Cover (1)	52	SFGC122-02E	Insulator (4)	N31	XWG3FZ	Washer (6)
2	SFTG172-01	Turntable Mat (1)	54	SFKT015-02E	Button, Speed (4S) (1)	N32	XSN3+14BVS	Screw (4)
3	SFTE172-01	Turntable Platter Ass'y (1)	55 (M)	SFNN122M10,	Name Plate (1)	N33	XWA3BFZ	Washer (4)
4	SFUM172-06	Cover, Cabinet (1)	55 (MC)	SFNN122C10	Name Plate (1)	N34	SFXG829-1	Screw (1)
5	SFMGQ20-01	Cover, Drive Coil (1)	55 (E)	SFNN122S10	Name Plate (1)	N35	XSN3+8S	Screw (2)
6	SFMG520-31A	Drive Coil Ass'y (1)	55 (EK,XL)	SFNN122G10	Name Plate (1)	N36	XUC5FT	Circlip (1)
7	SFMZ172-01E	FG Coil Ass'y (1)	55 (XA)	SFNN122X10	Name Plate (1)	N37	SFPEV17202	Screw (3)
8	SFMZQ20-01A	Shaft Ass'y, Turntable (1)	55 (PA,PE)	SFNN122P10	Name Plate (1)	N38	XTN3+25B	Screw (1)
			55 (PC)	SFNN122P11	Name Plate (1)	N39	SFPEW1100	Washer (1)
10	SFAC122-01	Cabinet (Silver) (1)	55 (Other areas)	SFNN122N10	Name Plate (1)	N40	XSN3+6BVS	Screw (4)
10	SFAC124S01	Cabinet (Black) (1)	55 (E)	SFNN124S10	Name Plate (1)	N41	XWC3BFZ	Washer (1)
11	SFUM172-04	Ornament, Stylus Illuminator (1)	55	SFNN124Q10	Name Plate (1)	N42	XSN3+12BVS	Screw (2)
12	SFKT122-01	Knob, Power Switch (1)	(E,G,EH)			N43	XWG3FZ	Washer (2)
13	SFKK122-01E	Case, Strobe Illuminator (1)	58	SFATM02N01A	Hinge (2)	N44	SFXW701-02	Washer (1)
14	SFKT015-06	Button, Start/Stop (1)	59	SFUP122-25	Plate, Power transformer (1)	N45	SFPEW00705	Washer (4)
15	SFQA122-01	Spring, Start/Stop Button (1)	TONARM PARTS			N46	XTW26+5E	Screw (1)
16	SFUM122-01	Base, Operation (1)	61	SFPC31001K	Headshell (1)	ACCESSORIES		
17	SFKT015-01E	Button, Speed (1)	62	SFPAM18201K	Tonearm Ass'y (Silver) (1)	A1 (M)	SFNU122M06	Instruction Book (1)
18	SFDJ122-02E	Connector, 7pin (1)	62	SEPAM18202K	Tonearm Ass'y (Black) (1)	A1 (MC)	SFNU122C06	Instruction Book (1)
19	SFGZ122-01	Spacer, Rubber (1)	63	SFPWG17201K	Balance Weight (1)	A1 (E,EB,EC)	SFNU122S01	Instruction Book (1)
20	SFYB-5-32	Ball, Switch Cam (1)	64	SFPRT18201K	Lift Ass'y (1)	A1 (EK)	SFNU122G01	Instruction Book (1)
21	SFOAS20-01	Spring, Switch Cam (1)	65	SFPZB17202	Knob, Arm Base Lock (1)	A1 (PA, PE,PC)	SFNU122P01	Instruction Book (1)
22	SFUM122-03	Cam, Power Switch (1)	66	SFQA829-03	Spring, Lift Ass'y (1)	A1 (Other areas)	SFNU122X01	Instruction Book (1)
23	SFUM015-11	Spacer, Speed Indicator (2)	67	SFPAB13202	Knob, Am Lift (1)	A2	SFWE010	45 Adaptor (1)
24	SFKK172-01	Cover, Stylus Illuminator (1)	68	SFPJL18202K	Oil Damper (1)	A3	SFPEN3302	Nut, Cartridge (2)
25	SFXB122-06	Boas, Drive (1)	70	SFPZB12203	Plate, Arm Base Cover (1)	A4	SFPEW9801	Washer, Cartridge (2)
26	SFOA172-01	Spring, Drive Boas (1)	71	SFUM170-06	Spacer, Phono Cord (1)	A5	SFCZV8801	Screw, Cartridge (2)
27	SFXJ172-01	Pin, Lock Canceler (1)	72	SEPZB12204	Clamper, Phono Cord (1)	A6	SFPEV9801	Screw, Cartridge (2)
28	SFUP122-02E	Bracket, Stylus Illuminator (1)	73	SFPAB18201K	Tonearm, Fixing Plate (1)	A7	SFK0135-01	Overhang Gauge (1)
29	SFUP122-03	Plate, Lock Operation (1)	74	SFPZB12201K	Plate (1)	A8	SFPZB3501	Shell Weight (1)
30	SFDJ122-03E	Connector, 3pin (1)	75	SFDH122-05	Phono Cord (1)	A8	SFDK19118	2pin Plug (1)
31	SFX0172-01	Pin, Guide (1)	76	SFEL028-01E	Ground Wire (1)	A10	SFPWG17202	Sub-weight (1)
32	SFOAS20-01	Spring, Lock Canceler (1)	77	SFPRT17201K	Arm Rest (1)	A11	QJ3P0603S	Adaptor, Gimens (1)
33	SFOA122-02	Spring, Lock Operation Plate (1)	78	SFPKD17203	Arm Base (Silver) (1)	PACKING PARTS		
34	SFXJ172-05	Pin, Lock Operation Plate (1)	78	SFPKD17205	Arm Base (Black) (1)	P1 (MC, EF)	SFHP122C02	Carton Box (Silver) (1)
35 (M,MC,PA PE,PC)	SFHK040L	Lock Operation Plate (1)	79	SFPKB17204E	Ring, Arm Base Operation (1)	P1 (Other areas)	SFHP122M02	Carton Box (Silver) (1)
35 (EK)	SFSR-5N-4	Clamper, AC Cord (1)	80	SFPKD12201	Bracket, Arm Base (1)	P1	SFHP124S02	Carton Box (Black) (1)
35 (Other areas)	SFSR-4N-4	Clamper, AC Cord (1)	81	SFPAB17206	Knob, Anti-Skating (1)	P2	SFHH122-01	Pad, Front (1)
36 (M,MC,PA PE,PC)	SFUP122-16	Bracket, AC Cord (1)	82	SFGK132-01	Cap (Silver) (1)	P3	SFHH122-02	Pad, Rear (1)
36 (Other areas)	SFUP122X01	Bracket, AC Cord (1)	82	SFGK133S01	Cap (Black) (1)	P4	SFHD122N05	Pad, Top (1)
37	RJA8Y	AC Cord (1)	SCREW, NUT AND WASHERS			P5	SFHD122-02	Pad (A), Turntable (1)
37 (M,MC)	QFC1205M	AC Cord (1)	N1	XTN3+8BFZ	Screw (5)	P6	SFHD122N06	Pad (B), Turntable (1)
37 (EK)	SJAG23	AC Cord (1)	N2	SFXGQ20-02	Screw (3)	P7	SFYH80X80	Polyethylene Bag, Unit & Dust Cover (2)
37 (XL)	SJA83	AC Cord (1)	N3	XTN3+8B	Screw (8)	P8	SFYH40X45	Polyethylene Bag, Turntable (1)
37 (PA,PE,PC)	SJA83	AC Cord (1)	N4	XWG3	Washer (1)	P9	SPB1083	Polyethylene Bag, Accessories (3)
37 (Other areas)	SJA88	AC Cord (1)	N5	XTN26+6B	Screw (3)	P10	SPJ15	Polyethylene Bag, Shell Weight (1)
38	SFGC122-03	Rubber, Power Transformer (2)	N6	XTV3+BBFN	Screw (8)	P11	SFHZD03M01	Cover Sheet, Dust Cover (1)
39	SFGC122-01	Cushion, Power Transformer (3)	N7	SFXG172-01	Screw (3)	P12	SFHZ122-01	Cover Sheet, 45 Adaptor (1)
41	SFKT122-02	Knob, Pitch Control (1)	N8	XTN3+5J	Screw (2)	P13	SPP189	Cover Sheet, Cords (2)
42	SFKK122-03	Ornament (Silver), Pitch Control (1)	N9	SFXW172-03	Washer (1)			
42	SFKK124S01	Ornament (Black), Pitch Control (1)	N10	SFPEW11003	Washer (6)			
43	SFUZ122-01	Felt (1)	N11	XWE3E10	Washer (3)			
44	SFUP122-09	Holder, LED (1)	N12	XWA3B	Washer (6)			
45	SFUP122-01	Bracket, Pitch Control (1)	N13	XSN3+10S	Screw (3)			
46	SFDJ122-01E	Connector, 4pin (1)	N14	SFXW910J02	Washer (1)			
48	SFAU122-02	Bottom Base (1)	N15	XTN3+10B	Screw (5)			
48-1	SFAU122-03	Bottom Cover (1)	N16	XTN2+10B	Screw (1)			
49	SFUP122-23	Supporter (A), Hinge (2)	N17	XUC3FT	Circlip (2)			
50	SFUP122-24	Supporter (B), Hinge (2)	N18	XSN17+3FY	Screw (1)			
51	SFUMM02N04	Case, Hinge (2)	N19	XUC2FT	Circlip (1)			
			N20	XUC25FT	Circlip (1)			
			N21	XSN3+14S	Screw (1)			
			N22	RTW-12	Circlip (1)			
			N23	XSN2+10	Screw (2)			
			N24	XSN3+6S	Screw (2)			
			N25	XTN3+6B	Screw (5)			
			N26	XTWS3+14TFZ	Screw (6)			
			N27	SFXG122-02	Screw (1)			
			N29	SFXG122-01	Screw (4)			
			N30	XTN3+14QFZ	Screw (6)			

EXPLODED VIEWS
 • Cabinet and Chassis Parts

Note: For the set with serial number sheet change mark **E**, the power transformer is fitted as shown below.

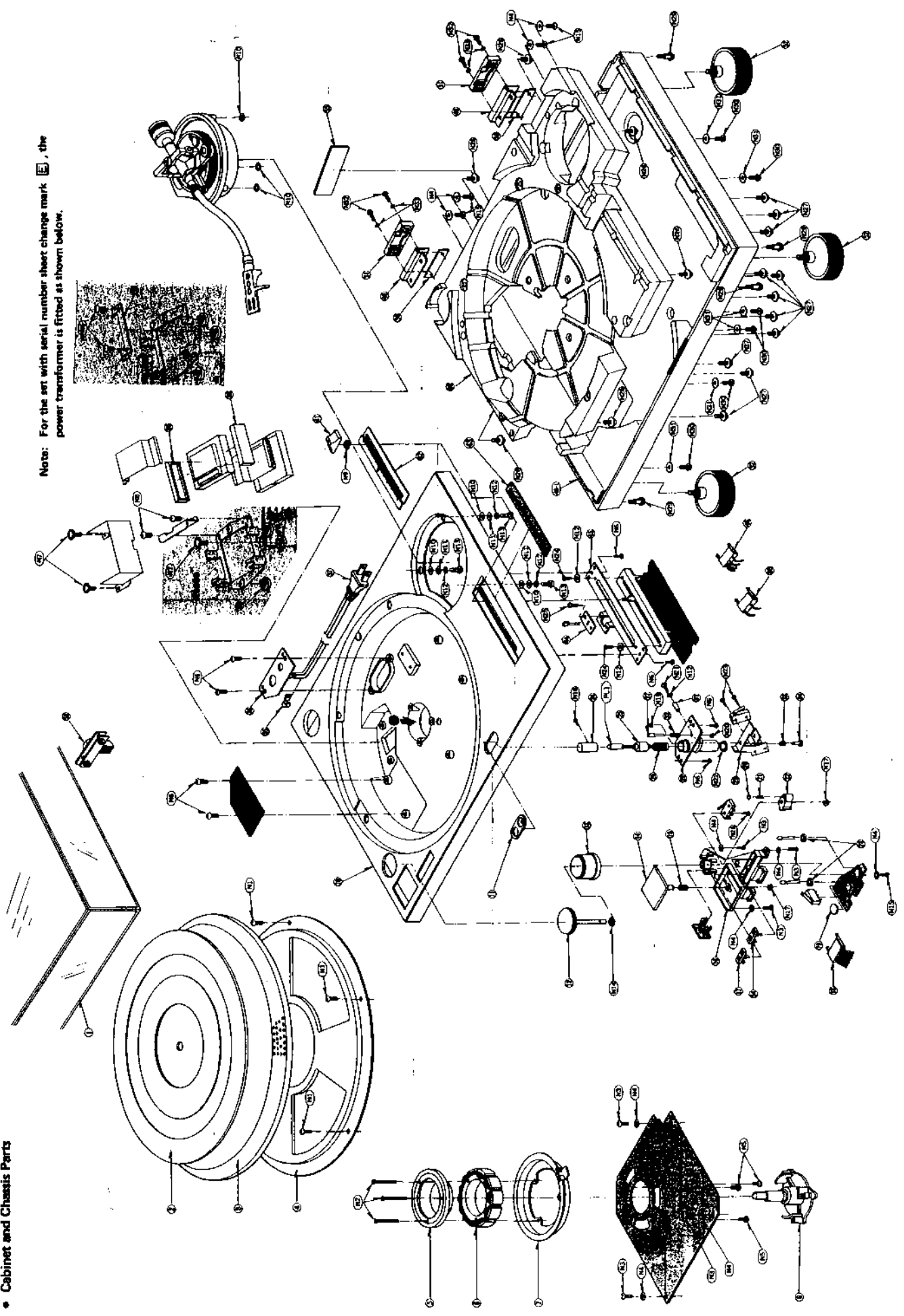

SL-1200MK2/1210MK2

• Tonearm Parts

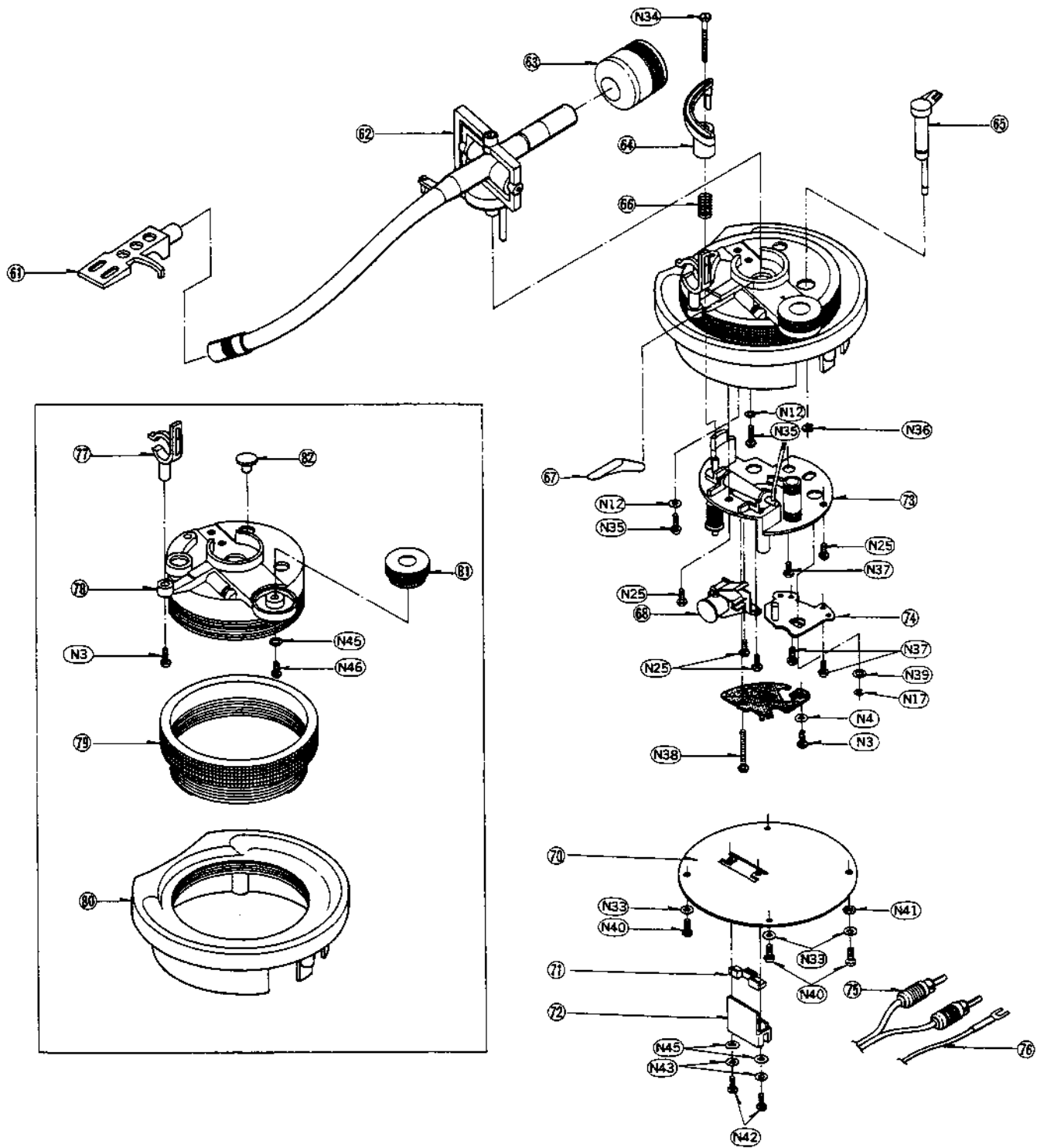

CIRCUIT BOARD AND WIRING CONNECTION DIAGRAM

- Power source circuit
- * Product for Cas

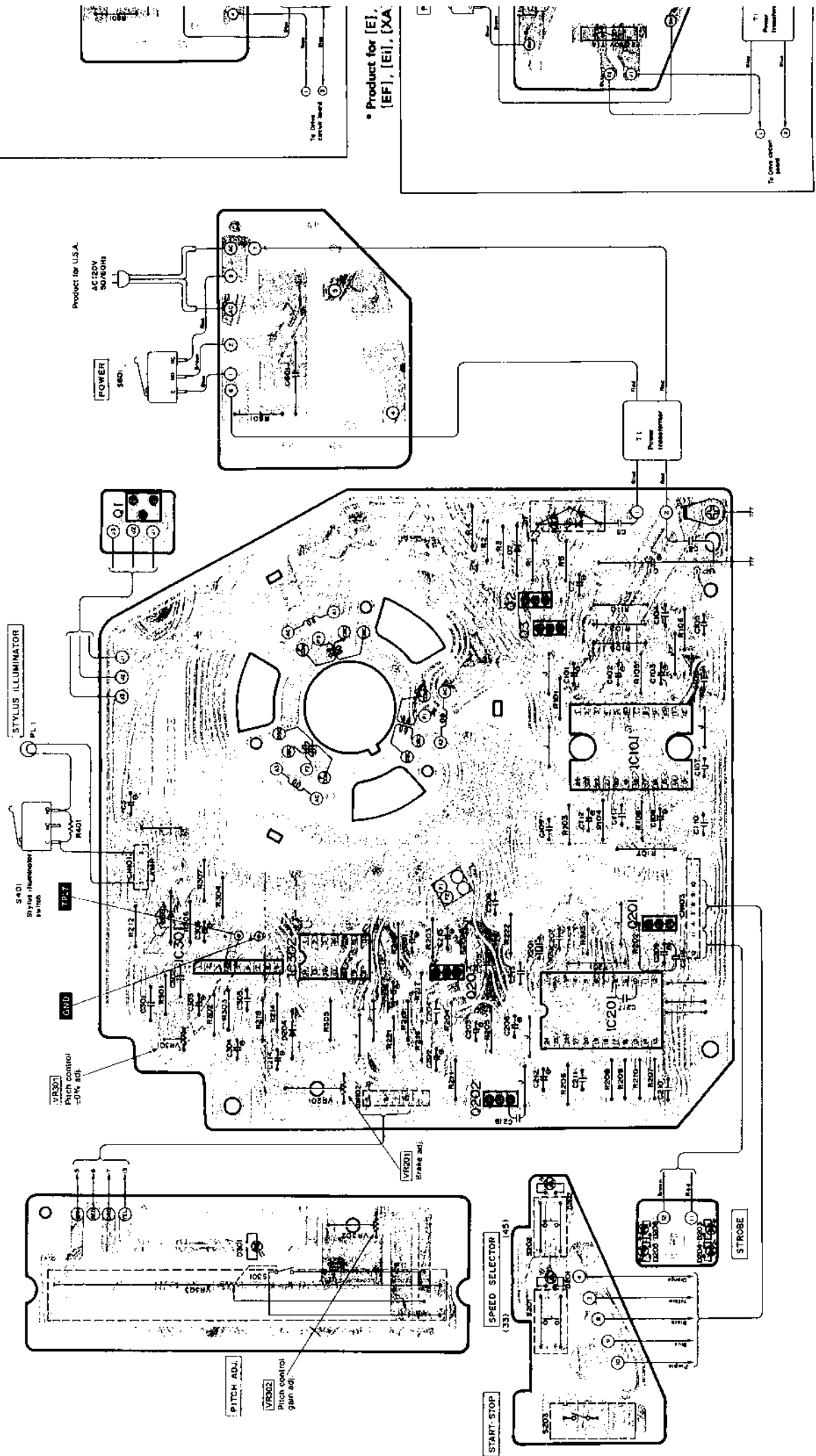

SL-1200MK2/1210MK2 SL-1200MK2/1210MK2

- Power source circuit
- * Product for Canada

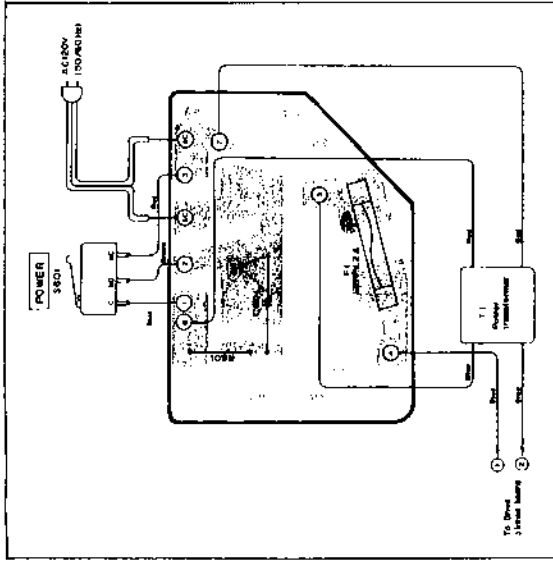

- * Product for [E], [EK], [XL], [EG], [EB], [EH], [EF], [Ei], [XA], [PA], [PE] and [PC] areas

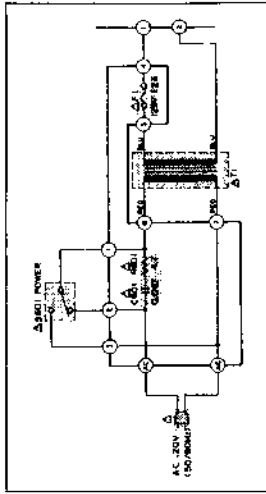
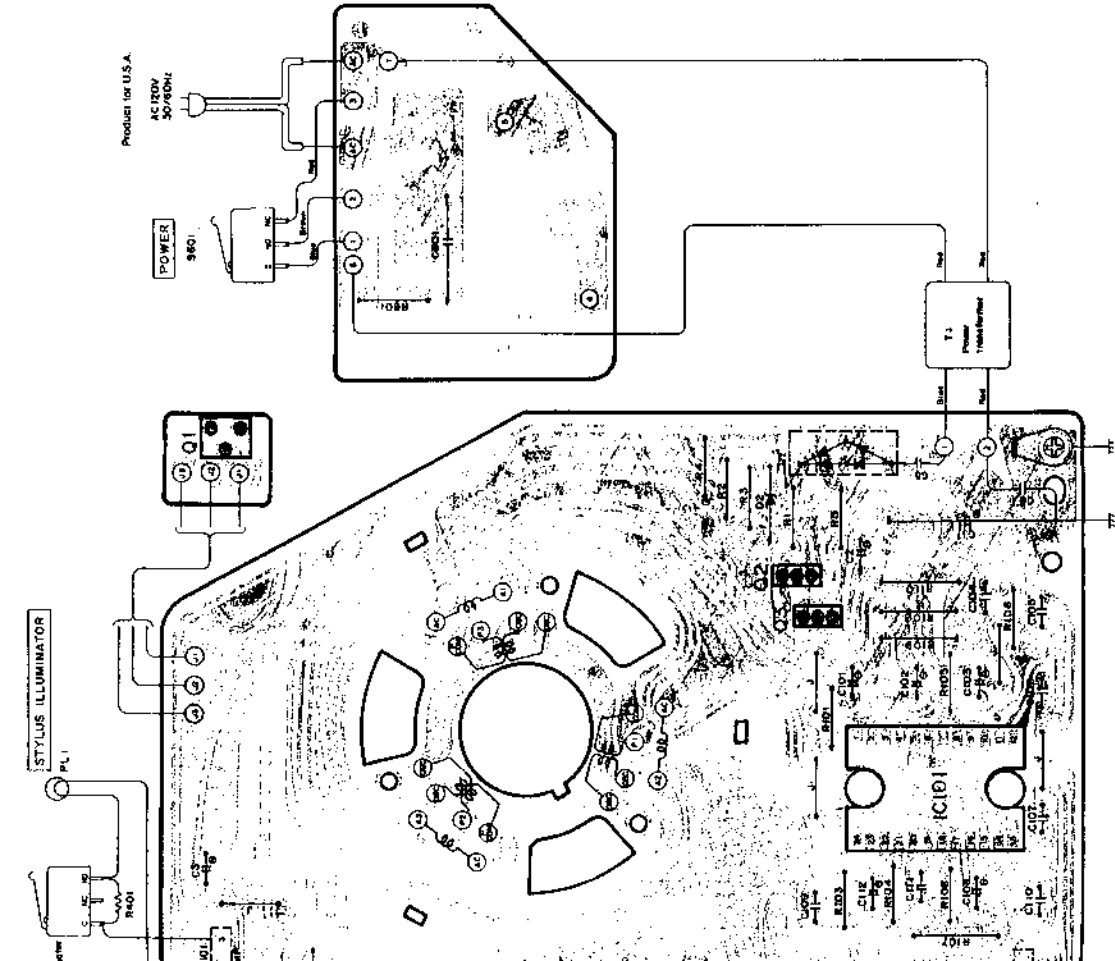
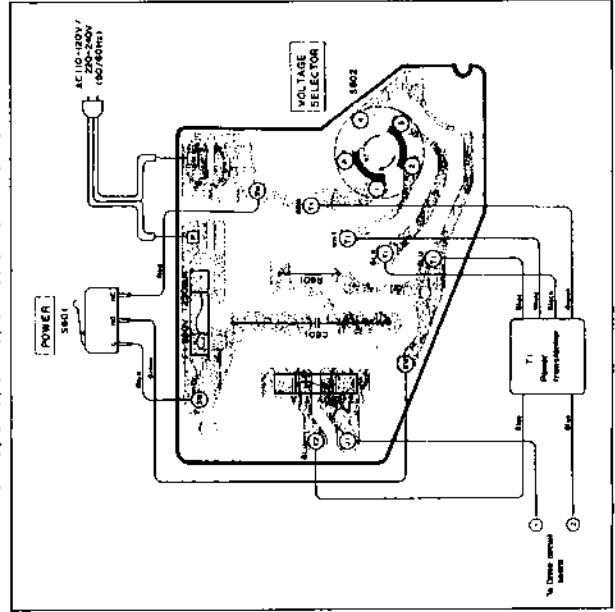

Product for MC only

FUSE REPLACEMENT

Symbol located near the fuse indicates fast operating type. For continued protection against fire hazard, replace with same type fuse. Refer to the symbol for fuse rating.

FUSIBLE REMPLACEMENT

Le symbole qui se trouve près du fusible signifie un fusible à action rapide. Pour une protection contre une éventuelle incendie, rEMPLACEZ-le par un fusible du même type. Se reporter au symbole pour le courant du fusible.

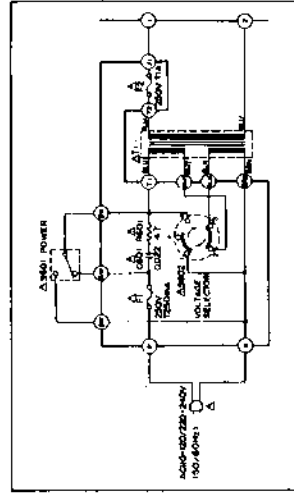

1 2 3 4 5 6 7 8 9 10

■ SCHEMATIC DIAGRAM

(This schematic diagram may be modified at any time with the development of new technology.)

Notes:

1. S201, 202 Speed selector switch.
2. S203 Start/stop switch.
3. S301 Pitch control reset switch in "off" position.
4. S401 Stylus illuminator switch in "off" position.
5. S601 Power switch in "on" position.
6. S602 Voltage selector in "220 - 240" position.
7. The voltage value and waveforms are the reference voltage values of this unit measured by DC electronic voltmeter (High-impedance) and oscilloscope on the basis of chassis. Therefore, the voltage value and waveform may include some error due to the internal impedance of the tester or the measuring set.
8. () is the voltage when turntable is in stop. (at 35 rpm)
9. () is 48 voltage lines.
10. Components identified by Δ mark have special characteristics important for safety. When replacing any of these components, use only manufacturer's specified parts.
11. The part No. of diodes mentioned in the schematic diagram stand for production part No. Regarding the part No. with \odot mark the production part No. are different from the replacement part No. Therefore, when placing an order for replacement part, please use the part No. in the replacement parts list.

IMPORTANT SAFETY NOTICE
 This schematic diagram is for reference only. It is not intended for production. The manufacturer is not responsible for any damage or injury caused by the use of this schematic diagram. The manufacturer is not responsible for any damage or injury caused by the use of this schematic diagram.

● Terminal guide of transistors, diodes and IC's

ANG675	ANG680	ANG682	ANG686	SVDS1R8A20F
MA1011B 14 Pin	MA150	MA1051	MA1051	MA1051
2SD1328	2SC1846	2SD1295	2SD1295	2SD1295
SVDR3902S-9	SVDSLH54VT3	SVDSL9NG2	SVDSL9NG2	SVDSL9NG2

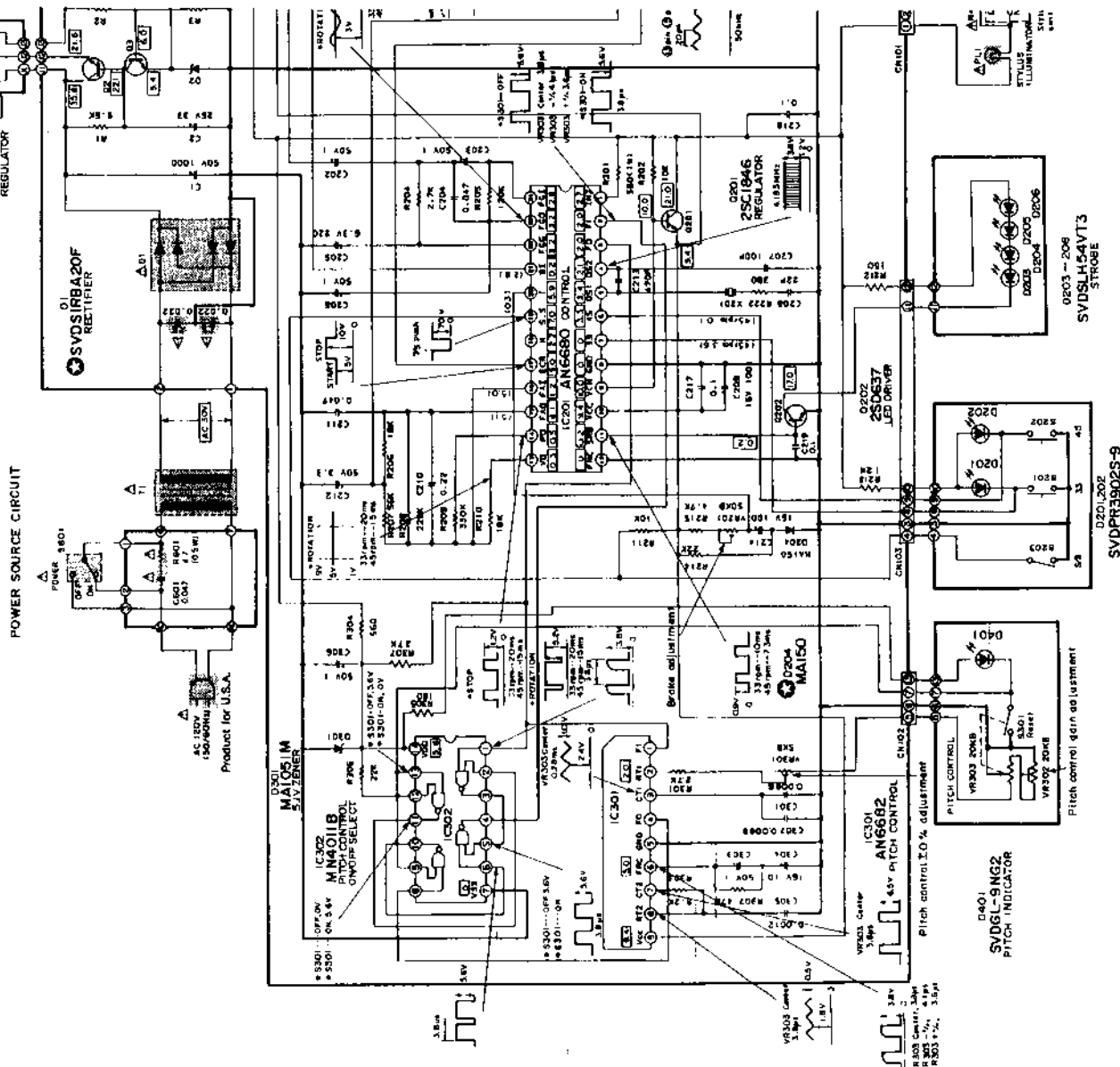

5 6 7 8 9 10 11 12 13 14

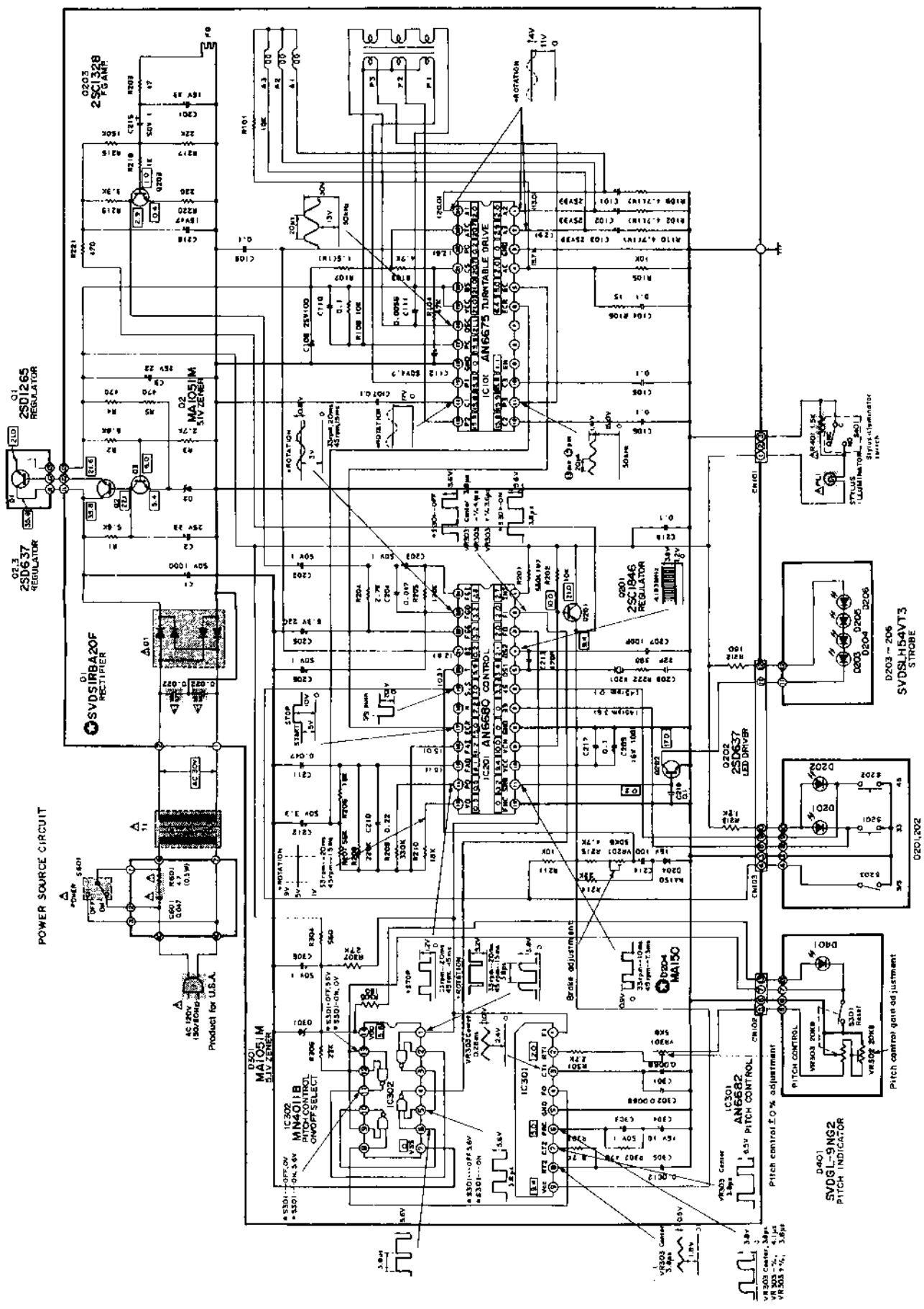

BLOCK DIAGRAM

TURNABLE DRIVE/CONTROL CIRCUIT

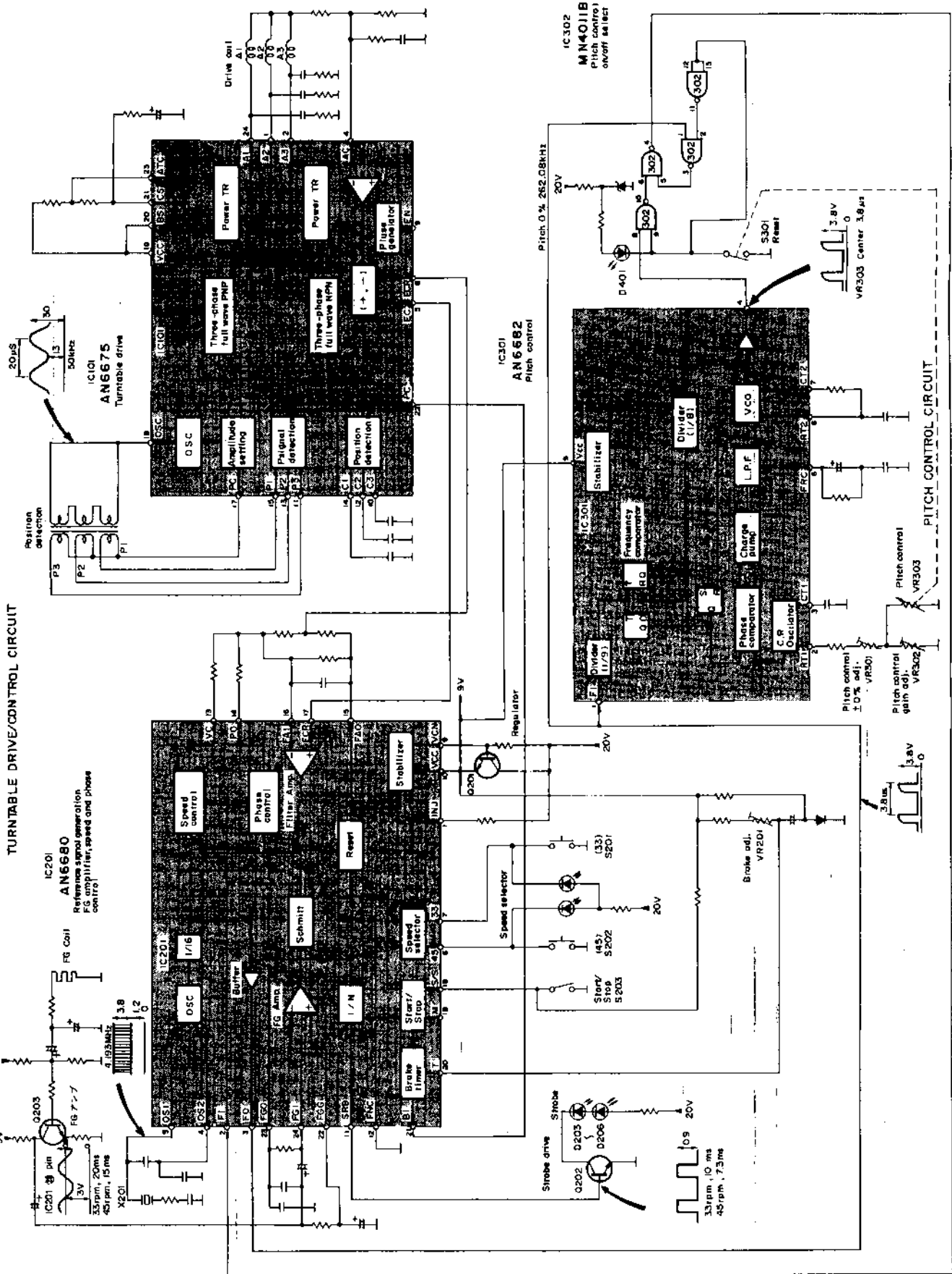

SL-1200MK2/1210MK2

PACKING

1. Place the unit (with cushions attached) as illustrated.
2. Fold the flaps according to the line marks.
3. Seal the top with adhesive tape.
 - * Use gum tape or adhesive cloth tape of 50mm wide at least.
4. For the edges, first fold the flap "a" and then flap "b", and staple. Remember to staple only flap "b". (Use 15 or 16mm staple)

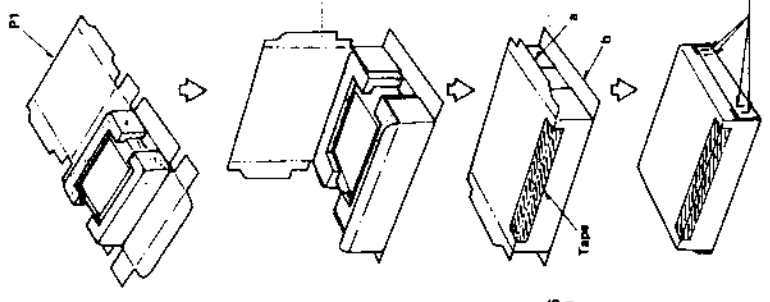
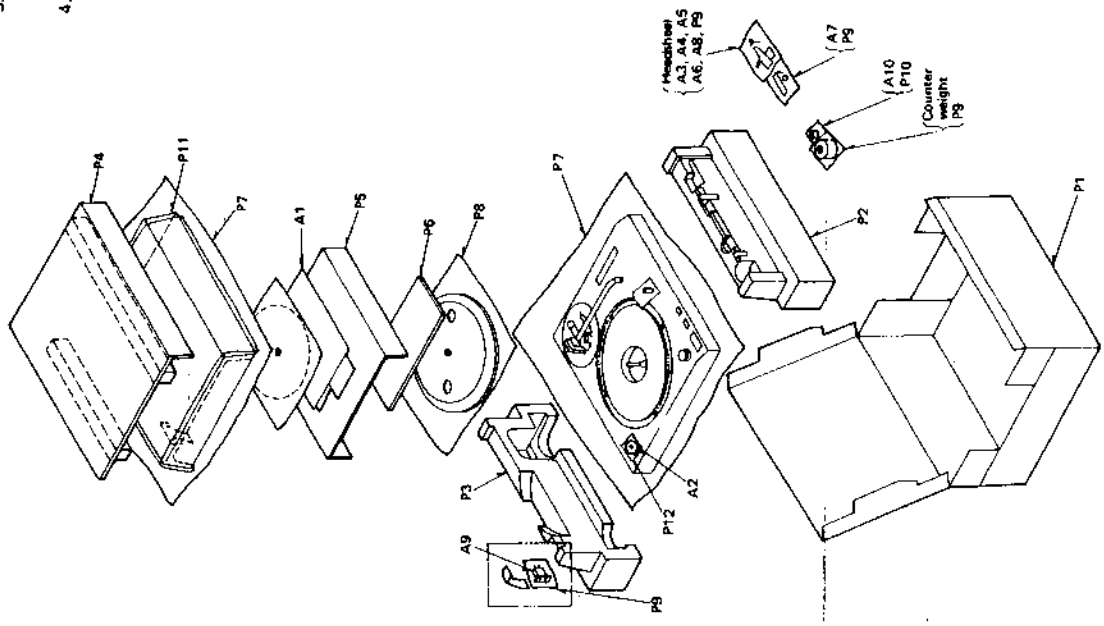

* Stapling positions are shown below.

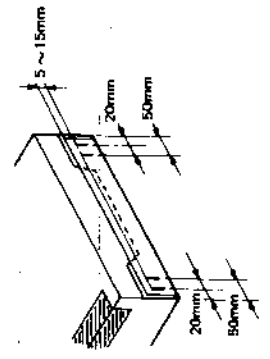

Service Manual

Turntable System

SL-1210MK2

[XG], [E]

Areas

- * [XG] is available in European.
- * [E] is available in Scandinavia.

For additional information, Please refer to the service manual for Model No. SL-1200MK2 [XG, XA, XGB, XAL, E]

- Notes:**
- * This service manual included only the change of the SL-1200MK2 [XG, XA, XGB, XAL, E] service manual (ORDER NO. SD7909-1622)
 - * When servicing model SL-1210MK2 [XG, E], this service manual and SL-1200MK2 (ORDER NO. 7909-1622) service manual should be used together.

CHANGES

REPLACEMENT PARTS LIST

Ref. No.	Change of Part No.		Part Name & Description	Per Set (Pcs.)	Remarks
	SL-1200MK2 [XG, XA, XGB, XAL, E]	→ SL-1210MK2 [XG, E]			
CABINET and CHASSIS PARTS					
10	SFAC122-01	SFAC124S01	Cabinet (Black)	1	○
35	SFSR4N4	SFSR4N4	Clamper, AC Cord	1	
	SFHK040L [XAL] only				
36	SFUP025X01	SFUP025X01	Blacket, AC Cord	1	
	SFUP025-01 [XAL] only				
37	RJA23ZC	SJA88	AC Cord	1	
	QFC1208M [XAL] only				
42	SFKK122-03	SFKK124S01	Ornament, Pitch Control Volume	1	
55	SFNN122N01	SFNN124Q01 [XG]	Name Plate	1	○
	SFNN122L01 [XAL] only				
	SFNN122S01 [E] only	SFNN124S01 [E]	Name Plate	1	○
— TONE ARM and ARM BASE PARTS					
62	SFPAM18201K	SFPAM18202K	Tone Arm Ass'y	1	○
82	SFGK132-01	SFGK133S01	Cap, Rubber	1	
PACKING PARTS					
P1	SFHP122M01	SFHP124S01	Carton Box	1	○

■ REPLACEMENT PARTS LIST (Mechanical)

- Notes: 1. Part numbers are indicated on most mechanical parts.
Please use this number for parts orders.
2. **△** indicates that only parts specified by manufacturer be used for safety.

Ref. No.	Part No.	Part Name & Description
CABINET and CHASSIS PARTS		
1	SFAD122-01A	Dust Cover
2	SFTG172-01	Turntable Mat
3	SFTE172-01Z	Turntable
4	SFUM172-05	Cover, Turntable
5	SFMGQ20-01	Cover, Stator Frame Ass'y
6	SFMG520-31A	Stator Frame
7	SFMZ172-01E	FG Detector Coil Ass'y
8	SFMZQ20-01A	Shaft, Stator Frame Ass'y
9	SFUP122-12	Plate, Shield
10	SFAC124S01	Cabinet
11	SFUM172-04	Ornament, Stylus-illuminator
12	SFKT122-01	Knob, Power Switch
13	SFKK122-01E	Case, Strobe-illuminator
14	SFKT015-06	Knob, Start/Stop Switch
15	SFQA122-01	Spring, Start/Stop Knob
16	SFUM122-01	Base, Operation
17	SFKT015-01E	Knob, Speed Selector (33-1/3 r.p.m.)
18	SFDJ122-02E	Connector, 7-PIN
19	SFGZ122-01	Spacer, Rubber (Speed Selector)
20	SFYB5-32	Ball, Switch Cam
21	SFQA520-01	Spring, Switch Cam
22	SFUM122-03	Cam, Switch
23	SFUM015-11	Spacer, LED
24	SFKK172-01	Cover, Lamp
25	SFXB122-02	Boss, Drive
26	SFQA172-01	Spring, Drive Boss
27	SFXJ172-01	Pin, Lock Canceler
28	SFUP122-02E	Bracket, Stylus-illuminator
29	SFUP122-03	Plate, Lock Operation
30	SFDJ122-03E	Connector, 3-PIN
31	SFXD172-01	Pin, Guide
32	SFQA520-01	Spring, Lock Canceler Pin
33	SFQA001-02	Spring, Lock Operating Plate M'tg
34	SFXJ172-05	Pin, Lock Operating Plate M'tg
35	SFSR4N4	Clamper, AC Cord
36	SFUP025X01	Bracket, AC Cord
37	△ SJA88	AC Cord
38	SFUP132-03	Bracket, Power Transformer
39	SFGC122-01	Cushion, Power Transformer
40	SFUP122-10	Spacer, Power Transformer
41	SFKT122-02	Knob, Pitch Control Volume
42	SFKK124S01	Ornament, Pitch Control Volume
43	SFUZ122-01	Shading Cloth, Pitch Control Volume
44	SFUP122-09	Holder, LED
45	SFUP122-01	Bracket, Pitch Control Volume
46	SFDJ122-01E	Connector, 4-PIN
47	SFUP122-13	Supporter, Bottom Base
48	SFAU122-01	Base, Bottom
49	SFUP122-05	Supporter (A), Hinge
50	SFUP122-04	Supporter (B), Hinge
51	SFUM170-07	Case, Hinge
52	SFGC122-02E	Audio Insulator
53	SFUP122-06	Supporter (C), Hinge
54	SFKT015-02E	Knob, Speed Selector (45 r.p.m.)
55 [XG]	SFNN124Q01	Name Plate
55 [E]	SFNN124S01	Name Plate
56	SFXD122-01	Pipe (A)
57	SFXD122-02	Pipe (B)
58	SFAT122-01A	Hinge Ass'y
STONE ARM and ARM BASE		
61	SFPCC31001K	Head Shell
62	SFPAM18202K	Tone Arm Ass'y
63	SFPWG17201K	Balance Weight Ass'y
64	SFPRT18201K	Lift Ass'y
65	SFPZB17202	Knob, Arm Base Lock
66	SFQAB29-03	Spring, Lift Ass'y
67	SFPAB13202	Knob, Arm Lift
68	SFPJL18202K	Oil Damper
70	SFPZB12203	Plate, Arm Base Cover
71	SFUM170-06	Spacer, Phono Cord
72	SFPZB12204	Clamper, Phono Cord
73	SFPAB18201K	Tone Arm Fixing Plate Ass'y

Ref. No.	Part No.	Part Name & Description
74	SFPZB12201K	Plate, Position Fix
75	SFDH028-01	Phono Cord
76	SFEL028-01E	Ground Wire
77	SFPRT17201K	Arm Rest
78	SFPK017203	Arm Base
79	SFPKB17201S	Ring, Arm Base Operation
80	SFPK012201	Bracket, Arm Base
81	SFPAB17206	Knob, Anti-skate Force Control
82	SFGK133S01	Cap, Rubber
SCREWS, WASHERS and CIRCLIPS		
●	XTN3+8BFZ	Screw
●	SFXGQ20-02	Screw
●	XTN3+8B	Screw
●	XTN26+6B	Screw
●	XTN4+10B	Screw
●	XWA4B	Washer
●	XUC3FT	Circlip
●	XUC2FT	Circlip
●	XUC25FT	Circlip
●	SFXW910J02	Washer
●	XTN3+40BFZ	Screw
●	XSN3+10BVS	Screw
●	XWE3F12FZ	Washer
●	XTN3+25BFZ	Screw
●	SFXW122-01	Washer
●	XWE3E10	Washer
●	SFPEW1100	Washer
●	SFPEW11003	Washer
●	XSN3+8S	Screw
●	SFXG172-01	Screw
●	XTV3+8BFN	Screw
●	XTN3+10B	Screw
●	XTN2+10B	Screw
●	XSN17+3FY	Screw
●	XSN3+14S	Screw
●	SFXW172-04	Washer
●	XUB14FT	Circlip
●	SFUZ172-05	O Ring
●	XTN3+6B	Screw
●	XSN3+6S	Screw
●	XWA3BFZ	Washer
●	XWA3B	Washer
●	XWG3	Washer
●	SFXG829-1	Screw
●	XUC5FT	Circlip
●	XTW3+6B	Screw
●	XTV3+6BFN	Screw
●	XWE4A10EW	Washer
●	XTN3+25B	Screw
●	XYN3+C6FZS	Screw
●	XSN3+12BVS	Screw
●	SFPEW17201	Washer
●	XWG26	Washer
ACCESSORIES		
A1 [XG]	SFNU122X01	Instruction Book
A1 [E]	SFNU122S01	Instruction Book
A2	SFWED10	Adaptor, 45 r.p.m.
A3	SFPEN3302	Nut, Cartridge
A4	SFPEW9601	Washer, Cartridge
A5	SFCZV8801	Screw, Cartridge
A6	SFPEV9801	Screw, Cartridge
A7	SFK0135-01	Overhang Gauge
A8	SFPZB3501	Shell Weight
PACKINGS		
P1	SFHP124S01	Carton
P2	SFHH122-01	Pad, Front
P3	SFHH122-02	Pad, Rear
P4	SFHD122-01	Pad, Top
P5	SFHD122-02	Pad, (A), Turntable
P6	SFHD122-03	Pad, (B), Turntable
P7	SFYH60X60	Polyethylene Cover, Turntable Unit and Dust Cover
P8	SFYH40X45	Polyethylene Cover, Turntable

Service Manual

SL-1200MK2

Turntable System

SL-1200MK2

(XG), (XA), (XGB)
(XAL), (E)

- The model SL-1200MK2 (XG) is available in European only.
- The model SL-1200MK2 (XA) is available in Asia, Latin America, Middle East and Africa only.
- The model SL-1200MK2 (XGB) is available in Belgium only.
- The model SL-1200MK2 (XAL) is available in Australia only.
- The model SL-1200MK2 (E) is available in Scandinavia only.

SPECIFICATIONS (Specifications subject to change without notice. Weight and dimensions shown are approximate.)

General

Power supply: ~110-120/220-240, 50 or 60 Hz
Power consumption: 13.5 W
Dimensions: 45.3 x 16.2 x 36 cm
 (W x H x D) (17-27/32" x 6-19/64" x 14-11/64")
Weight: 12.5 kg (27.6 lb)

Turntable section

Type: Quartz direct drive
Manual turntable
Drive method: Direct drive
Motor: Brushless DC motor
Turntable platter: Aluminum diecast
Diameter 33.2 cm (13-5/64")
Weight 2 kg (4.4 lb)
Turntable speeds: 33-1/3 rpm and 45 rpm
Starting torque: 1.5 kg.cm (1.3 lb.in)
Build-up characteristics: 0.7 s. from standstill to 33-1/3 rpm
Braking system: Electronic brake
Wow and flutter: 0.01% WRMS*
0.025% WRMS (JIS C5521)
±0.035% peak (IEC 98A Weighted)

* This rating refers to turntable assembly alone, excluding effects of record, cartridge or tonearm, but including platter. Measured by obtaining signal from built-in frequency generator of motor assembly.

Rumble: -56 dB (IEC 98A Unweighted)
-78 dB (IEC 98A Weighted)

Tonearm section

Type: Universal
Effective length: 230 mm (9-1/16")
Arm height adjustment range: 0-6 mm
Overhang: 15 mm (19/32")

Effective mass: 12-g-(without cartridge)
Offset angle: 22°
Friction: Less than 7 mg (lateral, vertical)
Tracking error angle: Within 2°32' (at the outer groove of 30 cm (12") record)
Stylus pressure adjustment range: Within 0°32' (at the inner groove of 30 cm (12") record)
0-2.5 g
Applicable cartridge weight range: 6-10 g
13.5-17.5 g (including headshell)
(with auxiliary weight): 9.5-13 g
17-20.5 g (including headshell)
(with shell weight) 3.5-6.5 g
11-14 g (including headshell)
Headshell weight: 7.5 g

Cartridge section

Model No.: EPC-207C
Type: Moving magnet
Frequency response: 20 Hz to 25 kHz
20 Hz to 15 kHz ±2 dB
Output voltage: 3 mV at 1 kHz
5 cm/s. zero to peak lateral velocity
[8.5 mV at 1 kHz 10 cm/s. zero to peak 45° velocity (DIN 45500)]
Channel separation: 25 dB at 1 kHz
Channel balance: Within 2 dB at 1 kHz
Compliance (dynamic): 10 x 10⁶ cm/dyne at 100Hz
Stylus pressure: 1.75 ±0.25 g (17.5 ±2.5 mN)
Load impedance: 47 kΩ to 100 kΩ
Weight: 5.6 g (cartridge only)
Replacement stylus: EPS-207ED
(Elliptical stylus)

TECHNISCHE DATEN

Allgemeine Daten

Stromversorgung: ~110-120/220-240 V, 50/60 Hz Wechselstrom

Leistungsaufnahme: 13,5 W

Abmessungen (B x H x T): 45,3 x 16,2 x 36 cm

Gewicht: 12,5 kg

Plattenspieler

Typ: Manueller Quarz-Direktantrieb

Plattenspieler

Direktantrieb

Motor: Kollektorloser Gleichstrommotor

Aluminium-Spritzguß

Durchmesser 33,2 cm

Gewicht 2 kg

Plattenteller-Drehzahlen: 33-1/3 und 45 U/min

Anlaufdrehmoment: 0,7 sec vom Stillstand auf 33-1/3 U/min

Bremsystem: Elektronische Bremse

Gleichlaufschwankungen: 0,01% WRMS*

±0,25% WRMS (JIS C5521)

±0,035% Spitze (IEC 98A bewertet)

Diese Nennleistung bezieht sich auf das Laufwerk-Bauteil allein, ausschließlich Einflüsse von Schallplatte, Tonabnehmer oder Tonarm, aber einschließlich Plattenteller. Gemessen anhand von Signalen vom eingebauten Frequenzgenerator des Motorbauteils.

Rumpel-Geräuschspannungsabstand: -56 dB (IEC 98A unbewertet)
-78 dB (IEC 98A bewertet)

Tonarm

Typ: Universal-Tonarm

Effektive Länge: 230 mm

Tonarmhöhe-Einstellbereich: 0-6 mm

Überhang: 15 mm

Effektive Masse: 12 g (ohne Tonabnehmer)

Kröpfungswinkel: 22°
Lagerreibung: Weniger als 7 mg (horizontal, vertikal)

Auflagekraft-Einstellbereich: 0-2,5 g

Zulässiger Ton-abnehmer-Gewichtsbereich: 6-10 g
13,5-17 g (einschließlich Tonarmkopf)

9,5-13 g

(mit Zusatz-Gegengewicht): 17-20,5 g (einschließlich Tonarmkopf)

Gewichtsbereich: 3,5-6,5 g

(mit Zusatzgewicht) 11-14 g (einschließlich Tonarmkopf)

Tonarmkopf-Gewicht: 7,5 g

Tonabnehmer

Modell-Nummer: EPC-207C

Magnetischer Tonabnehmer

Typ: 20 Hz bis 25 kHz

Frequenzgang: 20 Hz bis 15 kHz ±2 dB

Ausgangsspannung: 3 mV bei 1 kHz

5 cm/s. Null-zu-Spitze, lateral

[8,5 mV bei 1 kHz 10 cm/s. Null-zu-

Spitze, 45° (DIN 45500)]

Kanaltrennung: 25 dB bei 1 kHz

Kanalabweichung: Innerhalb 2 dB bei 1 kHz

Nachgiebigkeit (dynamisch): 10 x 10⁶ cm/dyn bei 100 Hz

Auflagekraft: 1,75 ±0,25 g (1,75 ±2,5 mN)

Impedanz: 47 kΩ bis 100 kΩ

Gewicht: 5,6 g (ohne Tonarmkopf)

Ersatznadel: EPS-207ED

(Elliptische Nadel)

Änderungen der technischen Daten vorbehalten.
Die angegebenen Gewichts- und Abmessungsdaten sind ungefähre Werte.

SPECIFICATIONS

Généralités

Alimentation: Alternatif 110-120/220-240V, 50 ou 60 Hz

Consommation: 13,5W

(L x H x P)

Poids: 12,5 kg

Platine de lecture

Typ: Entainement direct à quartz

Platine manuelle

Système d'entraînement:

Entraînement direct

Moteur: Moteur C.C. sans balai

Plateau de lecture: Aluminium moulé sous pression

Diamètre 33,2 cm

Poids 2 kg

Vitesse de rotation: 33-1/3 et 45 t/p.m

Couple de démarrage: 1,5 kg.cm

Caractéristiques d'augmentation:

0,7 s (rotation de 90°) à

33-1/3 t/p.m.

Système de freinage: Frein électronique

Plourage et scintillement: 0,01% de valeur efficace*

0,025% de valeur efficace (JIS C5521)

±0,035% de crête (IEC 98A Pondéré)

* Ce régime nominal se rapporte à l'ensemble du tournedisque, excluant les effets du disque, de la cellule pick-up ou de bras de lecture, mais comprenant le plateau. Mesuré par l'obtention d'un signal provenant du générateur de fréquences incorporé de l'ensemble du moteur.

Ronflement: -56 dB (IEC 98A Non pondéré)

-78dB (IEC 98A Pondéré)

Bras de lecture

Typ: Bras de lecture universel

Longueur effective: 230 mm

Portée du réglage de la hauteur du bras: 0-6 mm

Porte-à-faux: 15 mm

Masse réelle: 12 g (sans la cellule pick-up)

Angle d'erreur de piste: En deçà de 2°32' au sillon extérieur

d'un disque de 30 cm

En deçà de 0°32' au sillon intérieur

d'un disque de 30 cm

Angle de décalage: 22°

Frottement: Moins de 7 mg (latéral et vertical)

Plage de réglage de la pression d'appui: 0-2,5 g

Gamma du poids de la cellule pick-up utilisable: 6-10 g

13,5-17,5 g

(y compris la coque porte-cellule)

(avec contrepoids auxiliaire) 9,5-13 g

17-20,5 g

(y compris la coque porte-cellule)

(avec contrepoids de la cellule) 3,5-6,5 g

11-14 g

(y compris la coque porte-cellule)

Poids de la cellule: 7,5 g

Cellule pick-up

No. du modèle: EPC-207C

Type: Aimant mobile

Réponse en fréquence: 20 Hz à 25 kHz

20 Hz à 15 kHz ±2dB

Tension de sortie: 3 mV à 1 kHz; 5 cm/s. zéro à

vitesse latérale de crête

(8,5 mV à 1 kHz 10 cm/s., zéro à

vitesse 45° de crête (DIN 45500)]

25 dB à 1 kHz

Séparation de canal: En deçà de 2 dB à 1 kHz

Equilibrage des canaux: 10 x 10⁶ cm/dyne à 100 Hz

Elasticité (dynamique):

Pression de la pointe de lecture: 1,75 ±0,25 g (1,75 ±2,5 mN)

Impédance de charge: 47 kΩ to 100 kΩ

Poids: 5,6 grammes (cellule seule)

Pointa de lecture de remplacement: EPS-207ED

(Forme elliptique)

Les spécifications sont susceptibles d'être modifiées sans préavis.

Les poids et les dimensions donnés sont approximatifs.

■ CONTENTS

DISASSEMBLY PROCEDURE 3, 4
PARTS IDENTIFICATIONS 4
ARM BASE ASSEMBLING PROCEDURE 5
ADJUSTMENTS 6-8
SCHEMATIC DIAGRAM 9, 10
REPLACEMENT PARTS LIST (Electrical) 11
TROUBLE SHOOTING 12
PRINTED CIRCUIT BOARD 13, 14
BLOCK DIAGRAM 15, 16

ADJUSTMENTS (Electrical) 17
REFERENCE VOLTAGE AND WAVEFORM AT EACH IC PIN 17, 18
EXPLODED VIEWS 19, 20, 22
REPLACEMENT PARTS LIST (Mechanical) 21
FEATURES 23

■ DISASSEMBLY PROCEDURE

How to remove panel cover

1. Remove head shell and turntable.
2. Secure arm with arm clamp.
3. Remove 5 screws (A) of the panel cover as shown in Fig. 1.

How to remove stater frame coil and F.G detector coil

4. Remove 3 connectors (B) and 2 read wires (C) from power transformer as shown in Fig. 2.
5. Remove 3 screws (D) of the drive circuit board and 3 screws (E) of the stater frame cover as shown in Fig. 2.
6. Disconnect 18 soldered parts (F) of the stater coil and 4 soldered parts (G) of the F.G detector coil as show in Fig. 3.
7. Remove 3 screws (H) of the stater frame ass'y as shown in Fig. 3.

How to remove bottom base ass'y

8. Remove 4 audio insulators. (Counterclockwise rotation)
9. Remove 17 screws and spacer (I) as show in Fig. 4.
10. Remove 11 screws (J) as shown in Fig. 4.

How to remove stylus-illuminator lamp

11. Remove 2 screws (K) of the stylus-illuminator lamp ass'y as shown in Fig. 5.
12. Remove 1 screw (L) as shown in Fig. 6.

How to remove neon-illuminator L.E.D.

13. Remove 4 screws (M) as shown in Fig. 5.
14. Remove 1 circlip (N) and switch cam (O) as shown in Fig. 5.
15. Remove strobo-illuminator case.

How to remove tone arm

16. Remove 4 screws (P) of the arm base cover as shown in Fig. 5.
17. Remove 2 screws (Q) of the phono cord clammer as shown in Fig. 5.
18. Remove phono cord clammer as shown in Fig. 7.
19. Remove 2 screws (R) of the phono cord p.c.b. as shown in Fig. 8.
20. Remove 2 screws (S) as shown in Fig. 8.
21. Remove 2 screws (T) of the silicon oil dumper as shown in Fig. 8.
22. Remove 3 screws (U) as shown in Fig. 8.
23. Remove 2 screws (V) of the tone arm as shown in Fig. 9.

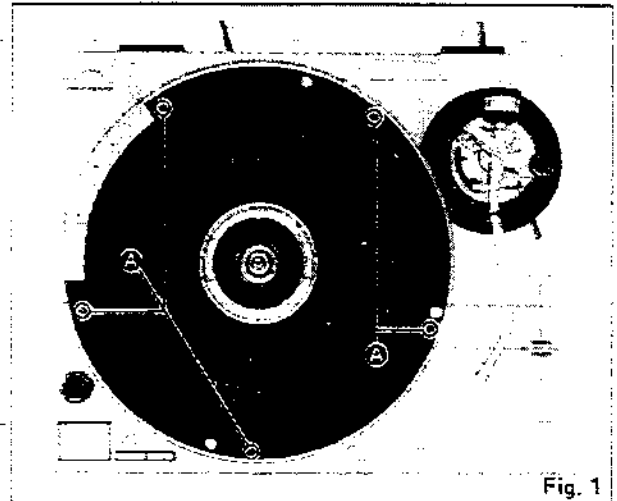

Fig. 1

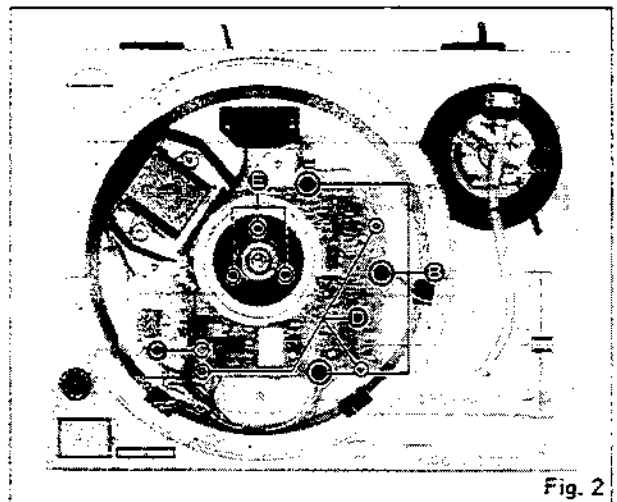

Fig. 2

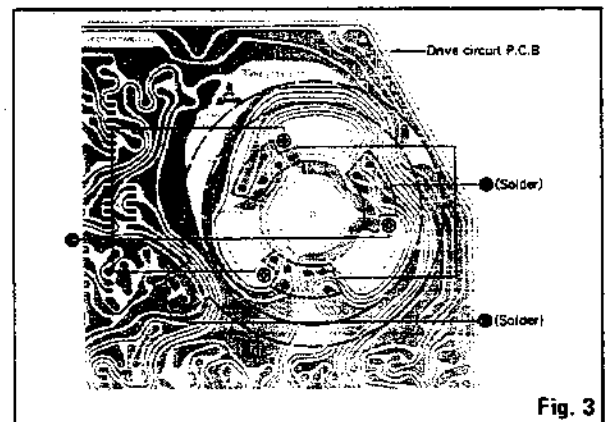

Fig. 3

SL-1200MK2

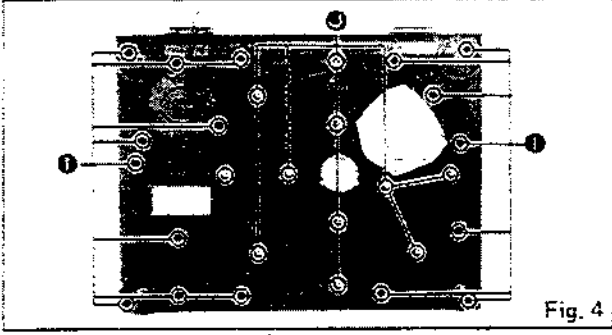

Fig. 4



Fig. 7

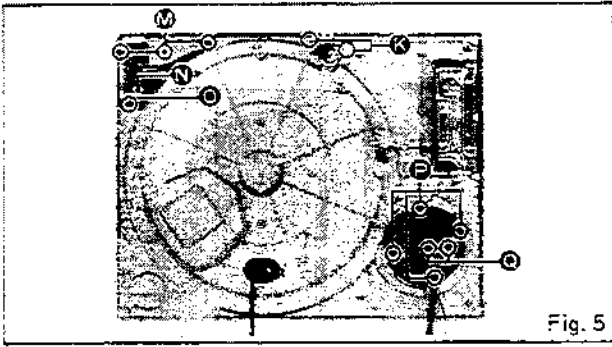

Fig. 5

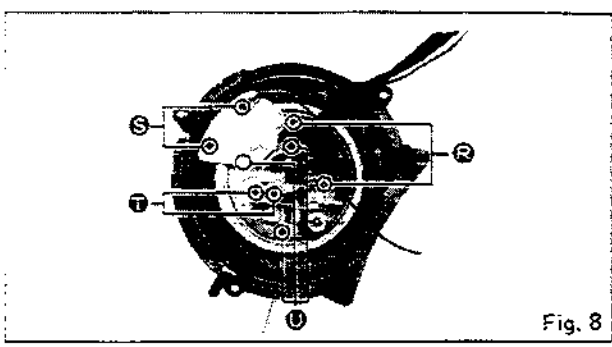

Fig. 8

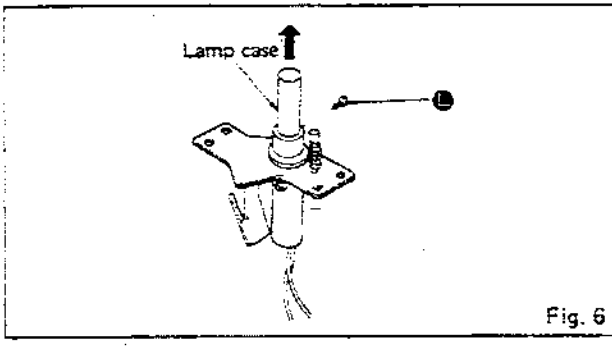

Fig. 6

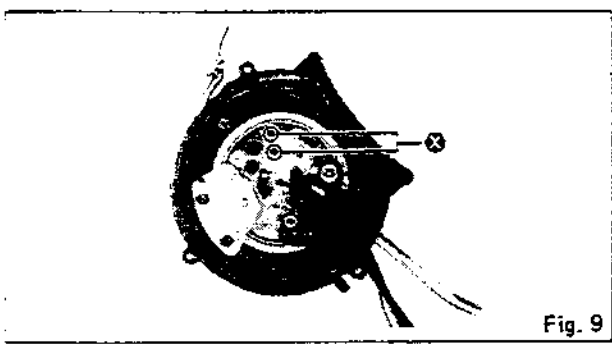

Fig. 9

■ PARTS IDENTIFICATION

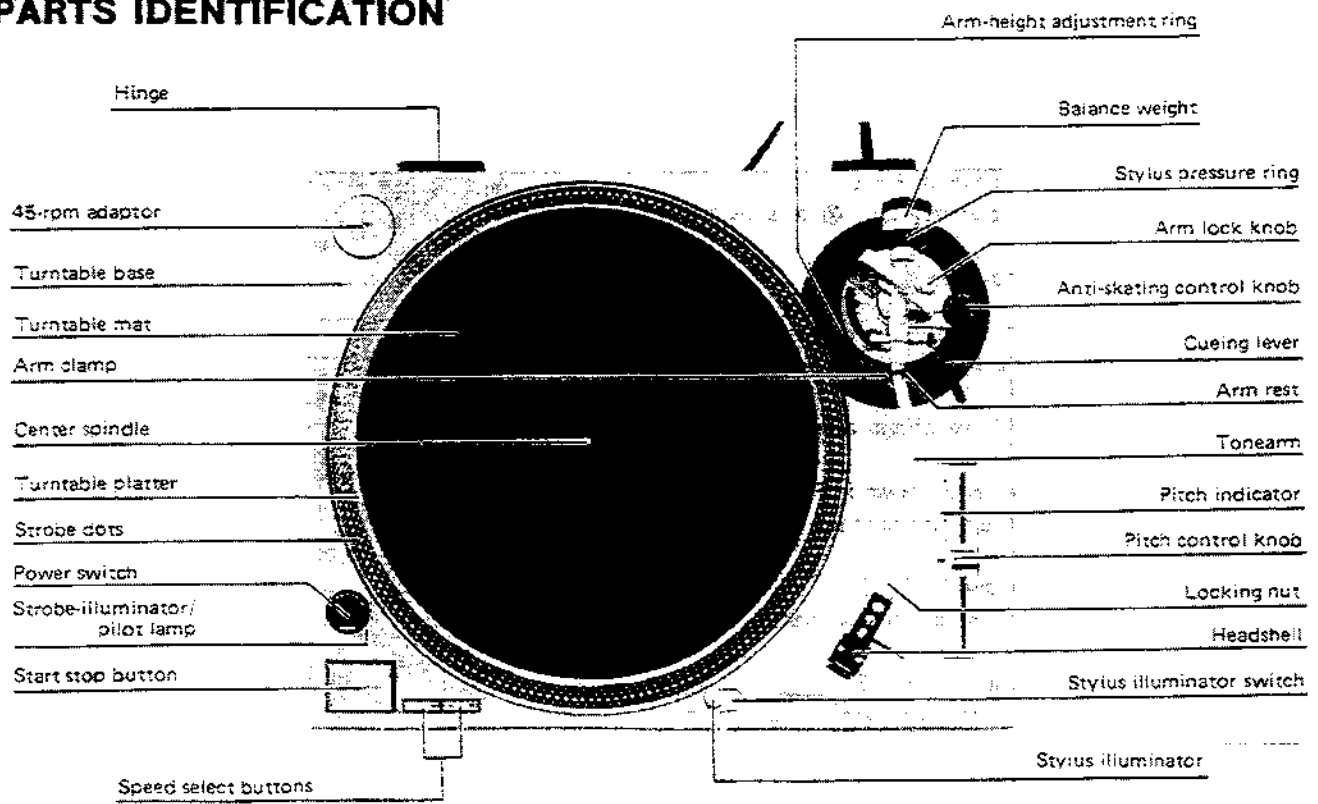

Fig. 10

■ ARM BASE ASSEMBLING PROCEDURE

1. Attach the control ring to the arm base seat. (The control ring should be roated counterclockwise.)
2. Completely tighten the control ring, and then loosen it 1.5~2.5 turns to set the scale to "3". (See Fig. 11)

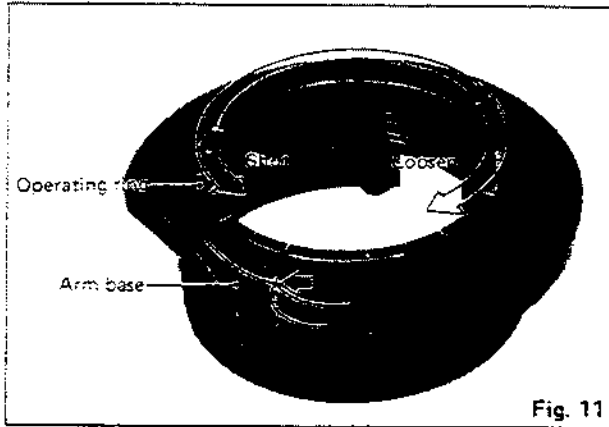

Fig. 11

3. Hold the arm base and set the red line mark on the arm base to the scale near "2", then turn the arm base clockwise. (See Fig. 12)

Note:

Take care not to allow deflection of the predetermined positions of the control ring and arm base seat.

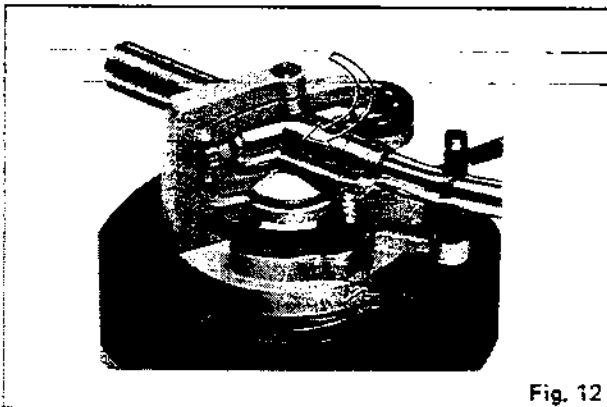

Fig. 12

4. Adjust the arm base so that the red line mark on the arm base is set to the scale "3" of the control ring. Next, secure the positioning base plate with two setscrews. (See Fig. 13)

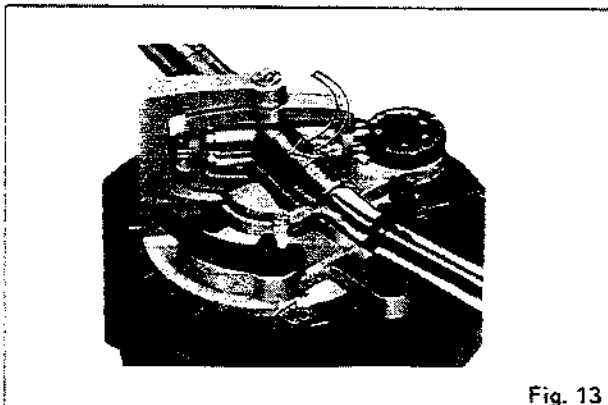

Fig. 13

5. Rotate the control ring and make sure that the arm base shifts within the range of 0~6mm. (See Figs. 14 and 15) If it does not shift within the specified range, the arm base position is deflected. In that case, disassemble the parts and check as specified in step 3.

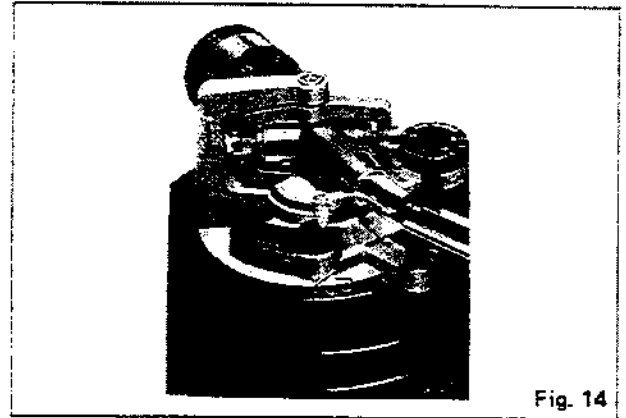

Fig. 14

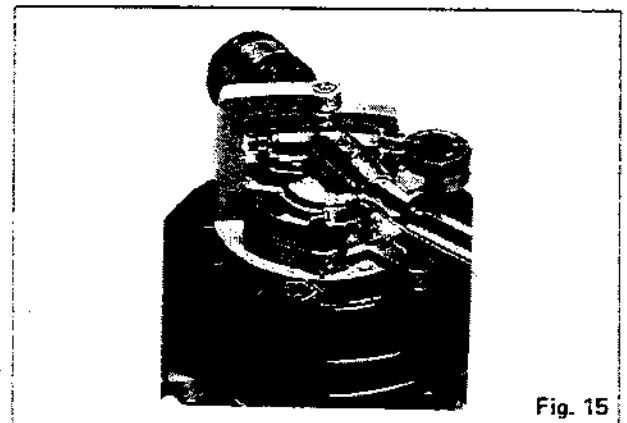

Fig. 15

■ ADJUSTMENT OF CANCELLER SPRING POSITION

If the arm body or PU base plate is replaced, be sure to set the canceller knob to "0.5" and make sure that the canceller spring is in contact with the arm shaft. (See Fig. 16)

If the canceller spring is deflected, adjust it as follows:

1. Clamp the arm on the rest.
2. Set the canceller knob to "0.5".
3. Remove the PU base plate, adjust gear A so that the canceller spring is in the position of Fig. 16.
4. Mount the PU base plate onto the arm base and check the spring position.

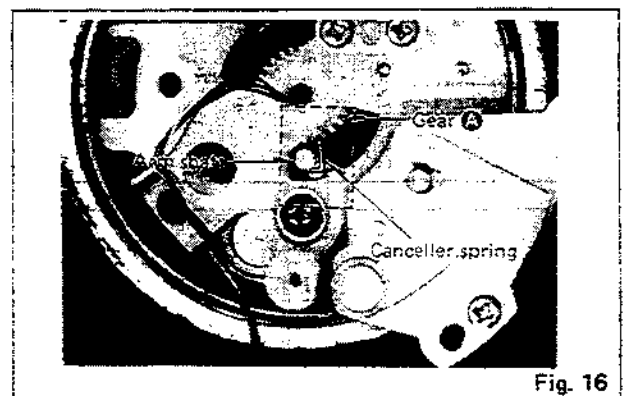

Fig. 16

■ ADJUSTMENTS

Pitch control (fine adjustment of speed) (See Figs. 18 and 19.)

When the pitch control knob is located at the center of the position after turning on the power, the green LED indicator is lit showing the operating condition for the predetermined speed (either 33-1/3 or 45 rpm). The pitch control is variable in a range of about $\pm 8\%$

Adjustment should be done on the basis of indicator scale. Figures on the indicator show approximate percentages for variable pitch control.

When the strobe dots in 4 stages marked at the peripheral edge of the turntable appear to be stationary, variation of individual pitches is shown. (See Fig. 19.)

Note:

The strobe-illumination of this unit employs a strobe-illuminator LED synchronized with the precise quartz frequency.

For fine adjustment of the turntable speed, be sure to effect the adjustment according to the LED illumination.

The LED illumination is not synchronized with fluorescent lamps.

Adjustment of arm-lift height (See Figs. 20 and 21.)

The arm-lift height (distance between the stylus tip and record surface when cueing lever is raised) has been adjusted at the factory before shipping to approximately 8-13mm.

If the clearance becomes too narrow or too wide, turn the adjustment screw clockwise or counterclockwise, while pushing the arm lift down.

Clockwise rotation

—distance between the record and stylus tip is decreased.

Counterclockwise rotation

—distance between the record and stylus tip is increased.

Note:

As the adjusting screw has hexagonal head, be sure to make the adjustment while depressing the arm lift, or the screw will not move freely.

Also be sure that the hexagonal head retracts correctly into the arm lift when the latter is released.

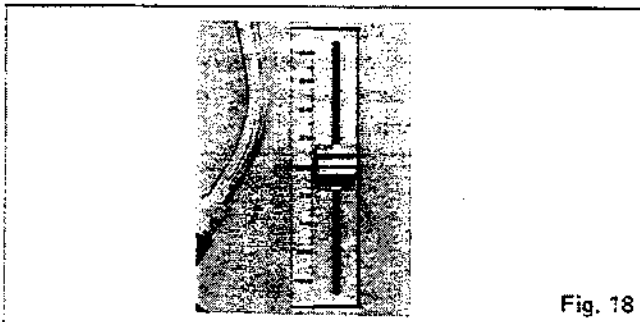

Fig. 18

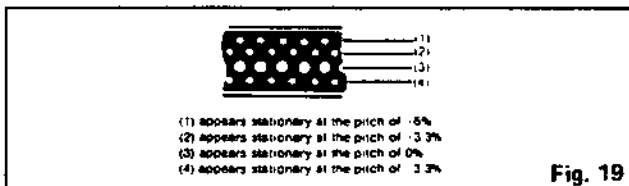

Fig. 19

Adjustment of the tonearm height (See Fig. 22.)

The height of the tonearm can be adjusted up to 6 mm, and a scale is provided on the adjust ring in 0.5 mm increments. Be sure to set the proper arm height using the adjust ring scale and referring to the table.

Height of cartridge (mm) (H)	Scale reading on the arm-height adjust ring
15	0
16	1
17	2
18	3
19	4
20	5
21	6

For example, if the cartridge height is 17.5 mm, the arm-height adjust ring should be positioned at the intermediate location between 2 and 3 on the scale. (See Fig. 22.)

Caution:

Be sure to lock the tonearm by turning the arm lock knob in the direction indicated by the arrow after finishing the height adjustment for the tonearm.

Lubrication (See Fig. 23.)

Apply 2 or 3 drops of oil once after every 2000 hours' of operation.

The time interval is much longer than that for conventional type motors (200-500 hours).

Please purchase original oil. (Part number is SFWO 010.)

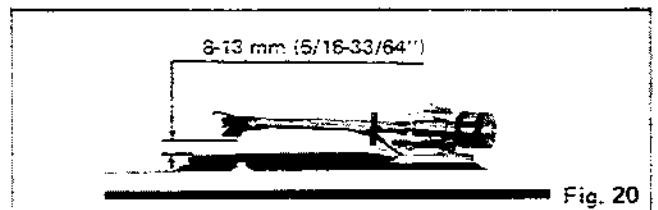

Fig. 20



Fig. 21



Fig. 22

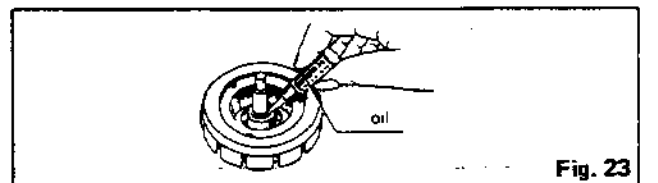

Fig. 23

■ JUSTIERUNGEN

Drehzahl-Feineinstellung (Vgl. Abb. 18 und 19.)
Wenn der Drehzahl-Feineinsteller beim Einschalten der Stromzufuhr in seiner mittleren Stellung ist, leuchtet der grüne LED-Anzeiger auf und zeigt den Betriebszustand für die vorgewählte Drehzahl (entweder 33-1/3 oder 45 U/min) an. Die Drehzahl ist über einen Bereich von ca. ±8% regelbar.

Die Zahlen auf dem Anzeiger geben ungefähre Prozentzahlen für die Drehzahlregelung an.
Wenn eine der vier Atroboskoppunkte an den Plattentellern stationär zu bleiben scheint, so wird dadurch die entsprechende Drehzahlabweichung (bzw. Nennzahl) angezeigt. (Vgl. Abb. 19.)

Anmerkung:
Die Stroboskopbeleuchtung dieses Plattenspieler verwendet eine Stroboskop-LED-Lampe, die mit der präzisen Quarzfrequenz synchronisiert ist.
Die Drehzahl-Feineinstellung muß unter der Beleuchtung durch diese LED-Lampe durchgeführt werden. Die LED-Lampe ist nicht mit Leuchtstofflampen synchronisiert.

Justierung der Tonarmhöhe

(Vgl. Abb. 20 und 21.)
Die Tonarmhöhe, d.h. der Abstand zwischen Nadelspitze und Schallplattenoberfläche, wenn der Lift-Hebel angehoben ist, ist werkseitig auf ungefähr 8-13 mm eingestellt worden.
Falls der Abstand zu groß oder zu klein wird, drehen Sie die Justierschraube im Uhrzeigersinn oder gegen Uhrzeigersinn während Sie die Tonarmführung nach unten drücken.
Drehung im Uhrzeigersinn
-Der Abstand wird kleiner.
Drehung im Gegen Uhrzeigersinn
-Der Abstand wird größer.

■ JUSTIERUNGEN (Elektrisch)

Anmerkung: ● Nach Teilmontierung von z.B. IC, Transistor, Diode usw. die folgende Abgleichung vornehmen.
● Einstellung der Geräte:
1. Netzschalter - ON
2. Tonhöhe Kontrolle Mittlere Stellung.

Abgleichung	Anschlußpunkte	Abgleichsmodus
A Abgleich der Tonhöhe Kontrolle ±0% (PITCH)	Signalfrequenzmesser ① TP27 ② GROUND	VR301 1. Schalter für Tonhöhekontrolle auf Mittlereinstellung 2. VR301 auf 262,06 kHz ±0,05 kHz abgleichen.
B Abgleich des Tonhöhensteuergeräts	Prüfgerät TP31 und TP32	VR302 VR302 auf 2,7K ±0,1 des Widerstandwertes einstellen.
C Stromen Justierung (BRAKE)	---	VR201 VR201 innerhalb 120°-270° nach Halbleiterschaltung auf Kompletten Halbi Justieren. (Plattenteller wird ein paar Sekunden nach Halt frei.) Haltsignal



Anmerkung:
Da die Justierschraube einen Sechskantkopf hat, muß die Tonarmführung während des Justierens unbedingt gedrückt gehalten werden, damit sich die Schraube leicht drehen läßt.
Vergewissern Sie sich, daß der Sechskantkopf in die Tonarmführung zurückkehrt, wenn diese abgelassen wird.

Justierung des Antiskating-Einstellers

Stellen Sie den Antiskating-Einstellknopf auf den gleichen Wert ein, wie den Aufgedruck. (Vgl. Abb. 13.)

Justierung der Tonarmhöhe

(Vgl. Abb. 22.)
Die Tonarmhöhe kann mittels eines Justiering, dessen Skala in Stufen von 0,5 mm unterteilt ist, um bis zu 6mm reguliert werden. Nehmen Sie die Justierung gemäß nachstehender Tabelle vor.

Tonabnehmerhöhe (mm) (H)	Skaleneinstellung auf dem Tonarmhöhe-Justiering
15	0
16	1
17	2
18	3
19	4
20	5
21	6

Falls die Tonarmhöhe beispielsweise 17,5 mm beträgt, sollte der Justiering zwischen die Skaleneinstellungen 2 und 3 eingestellt werden. (Vgl. Abb. 22.)

Achtung:

Nach erfolgter Tonarmhöhe-Justierung muß der Tonarm unbedingt durch Drehen des Tonarmverriegelungskopfs in der Pfeilrichtung festgestellt werden.

Anmerkung: ● Nach Teilmontierung von z.B. IC, Transistor, Diode usw. die folgende Abgleichung vornehmen.
● Einstellung der Geräte:
1. Netzschalter - ON
2. Tonhöhe Kontrolle Mittlere Stellung.

Abgleichung	Anschlußpunkte	Abgleichsmodus
A Abgleich der Tonhöhe Kontrolle ±0% (PITCH)	Prüfgerät TP27 ② GROUND	VR301 1. Schalter für Tonhöhekontrolle auf Mittlereinstellung 2. VR301 auf 262,06 kHz ±0,05 kHz abgleichen.
B Abgleich des Tonhöhensteuergeräts	Prüfgerät TP31 und TP32	VR302 VR302 auf 2,7K ±0,1 des Widerstandwertes einstellen.
C Stromen Justierung (BRAKE)	---	VR201 VR201 innerhalb 120°-270° nach Halbleiterschaltung auf Kompletten Halbi Justieren. (Plattenteller wird ein paar Sekunden nach Halt frei.) Haltsignal



■ REGLAGES

Reglage d'écart (mise au point exacte de la vitesse)

(Voir Figs. 18 et 19.)
Lorsque la manette de réglage d'écart est située à la position centrale une fois l'alimentation mise en marche, l'indicateur à diode électro-luminescente (LED) verte s'éclaircit pour indiquer la condition de fonctionnement de la vitesse prédéterminée (soit 33-1/3 ou 45 1/2 p.m.). Le réglage d'écart est ajustable dans une plage d'à peu près 8%.

La mise au point devra être faite en se basant sur la graduation de l'indicateur. Les chiffres sur l'indicateur montrent les pourcentages approximatifs pour un réglage d'écart variable.

Lorsque les points stroboscopiques sur les quatre gradins du bord périphérique du plateau semblent être immobiles, la variation des écarts individuels est représentée. (Voir Fig. 19.)

Nota:

L'éclairage stroboscopique de cet appareil utilise un illuminomètre stroboscopique à diodes électro-luminescentes (LED) synchronisé avec une fréquence à quartz précise.
Pour une mise au point exacte de la vitesse du plateau, s'assurer d'effectuer le réglage selon l'éclairage de la diode électro-luminescente.

L'éclairage à diodes électro-luminescentes ne se synchronise pas avec l'utilisation de lampes fluorescentes.

Mise au point de la hauteur de l'élevateur du bras

(Voir Figs. 20 et 21.)
La hauteur de l'élevateur du bras (distance entre l'extrémité de la pointe de lecture et la surface du disque lorsque le levier de pose et de relevage du bras est soulevé) a été réglée en usine avant son départ sur une valeur approximative de 8 - 13 mm.

Si l'écartement devient trop étroit ou trop large, tourner la vis de réglage dans le sens des aiguilles d'une montre ou en sens inverse, tout en abaissant l'élevateur du bras.

Rotation dans le sens des aiguilles d'une montre.
- La distance entre la surface du disque et l'extrémité de la pointe de lecture diminue.

■ REGLAGES (Electricité)

Notes: ● Effectuer les réglages suivants après avoir remplacé des éléments tels que les IC, transistors, diodes, et autres.
● Etat de l'appareil:
1. Commutateur d'alimentation - Marche
2. Commutateur d'alignement de la vitesse Position centrale

Points de réglage	Points de connexion	Points de réglage
VR301	Fréquence ① TP27 ② TERRE	1. Commutateur de commande d'alignement de la vitesse en position centrale 2. 262,06 kHz ±0,05 kHz
VR302	Contrôleur TP31 et TP32	Régler la VR302 sur la valeur de la résistance de 2,7K ±0,1
VR201	---	Régler la VR201 sur l'envoi du signal d'arrêt. (Le plateau devient libre quelques secondes après l'arrêt.) Signal d'arrêt



Rotation dans le sens contraire des aiguilles d'une montre.
- La distance entre la surface du disque et l'extrémité de la pointe de lecture augmente.

Nota:

Comme le vis de réglage possède une tête hexagonale, s'assurer d'effectuer la mise au point tout en abaissant l'élevateur du bras, sinon la vis ne bougera pas librement. Vérifier aussi que la tête hexagonale se retire correctement dans l'élevateur du bras quand ce dernier est libre.

Mise au point de la hauteur du bras de lecture

(Voir Fig. 22.)
La hauteur des bras de lecture peut être réglée jusqu'à 6 mm et une graduation est disposée sur la bague de réglage par augmentation de 0,5 mm. S'assurer de régler convenablement la hauteur du bras en utilisant la graduation de la bague et en se référant au tableau ci-dessous.

Hauteur de la cellule de lecture (mm) (H)	lecture de la graduation sur la bague de réglage de la hauteur du bras
15	0
16	1
17	2
18	3
19	4
20	5
21	6

Par exemple, si la hauteur de la cellule de lecture est de 17,5 mm, la bague de réglage de la hauteur du bras devra être positionnée à l'emplacement intermédiaire entre les lectures de la graduation 2 et 3 indiquées sur la graduation. (Voir Fig. 22.)

Avertissement:

S'assurer de bloquer le bras de lecture en tournant la manette de blocage du bras dans la direction indiquée par la flèche, après avoir terminé la mise au point de la hauteur du bras de lecture.

Schematic Diagram (This schematic diagram may be modified at any time with the development of new technology.)

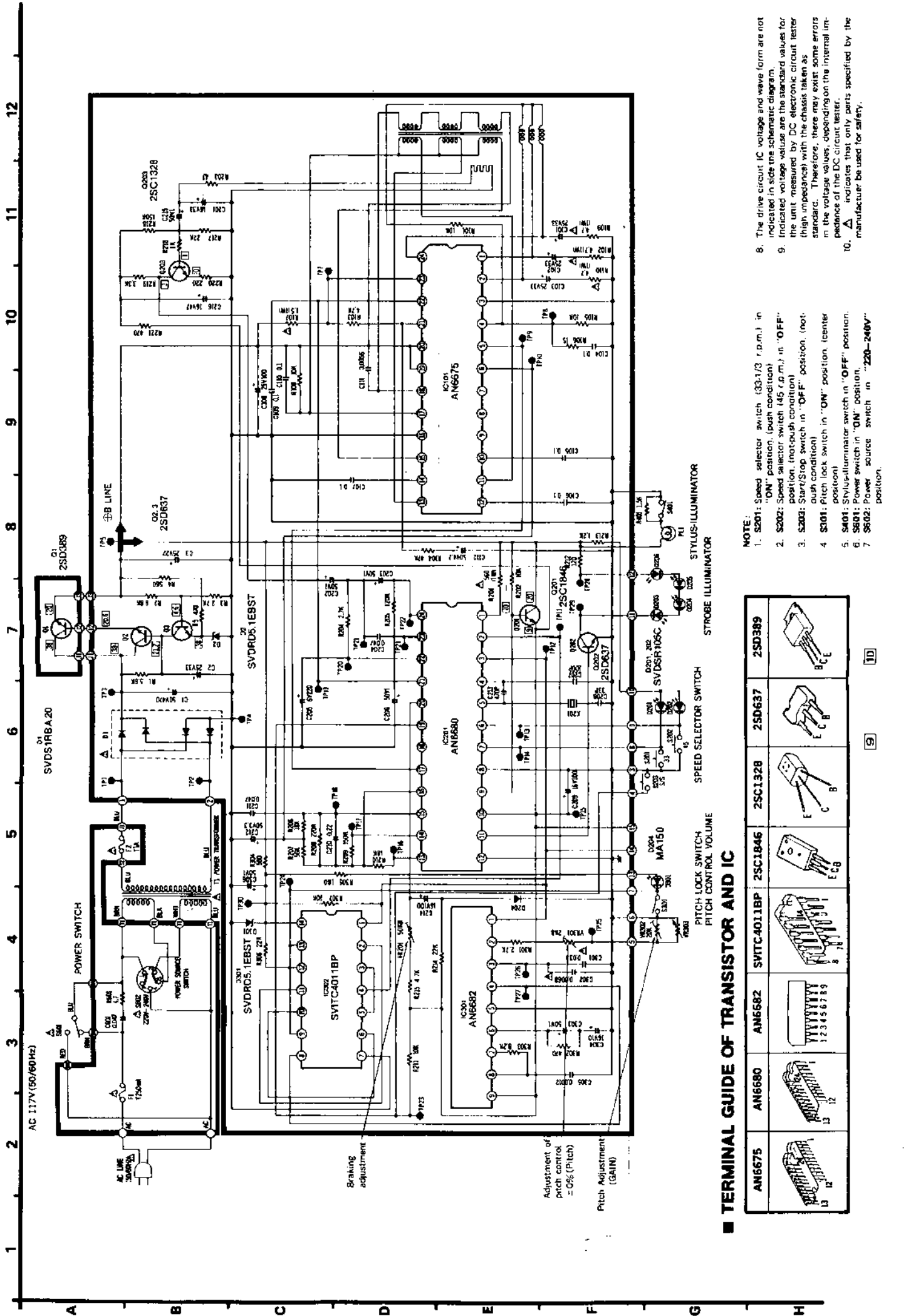

■ TERMINAL GUIDE OF TRANSISTOR AND IC

AN6675	AN6680	AN6682	SVTCA011BP	2SC1846	2SC1328	2SD637	2SD389	
13 12	13 12	12 3 4 5 6 7 8	1 2 3 4 5 6 7 8 9 10 11 12 13 14 15 16 17 18 19 20 21 22 23 24 25 26 27 28 29 30 31 32 33 34 35 36 37 38 39 40 41 42 43 44 45 46 47 48 49 50 51 52 53 54 55 56 57 58 59 60 61 62 63 64 65 66 67 68 69 70 71 72 73 74 75 76 77 78 79 80 81 82 83 84 85 86 87 88 89 90 91 92 93 94 95 96 97 98 99 100	1 2 3 4 5 6 7 8 9 10 11 12 13 14 15 16 17 18 19 20 21 22 23 24 25 26 27 28 29 30 31 32 33 34 35 36 37 38 39 40 41 42 43 44 45 46 47 48 49 50 51 52 53 54 55 56 57 58 59 60 61 62 63 64 65 66 67 68 69 70 71 72 73 74 75 76 77 78 79 80 81 82 83 84 85 86 87 88 89 90 91 92 93 94 95 96 97 98 99 100	1 2 3 4 5 6 7 8 9 10 11 12 13 14 15 16 17 18 19 20 21 22 23 24 25 26 27 28 29 30 31 32 33 34 35 36 37 38 39 40 41 42 43 44 45 46 47 48 49 50 51 52 53 54 55 56 57 58 59 60 61 62 63 64 65 66 67 68 69 70 71 72 73 74 75 76 77 78 79 80 81 82 83 84 85 86 87 88 89 90 91 92 93 94 95 96 97 98 99 100	1 2 3 4 5 6 7 8 9 10 11 12 13 14 15 16 17 18 19 20 21 22 23 24 25 26 27 28 29 30 31 32 33 34 35 36 37 38 39 40 41 42 43 44 45 46 47 48 49 50 51 52 53 54 55 56 57 58 59 60 61 62 63 64 65 66 67 68 69 70 71 72 73 74 75 76 77 78 79 80 81 82 83 84 85 86 87 88 89 90 91 92 93 94 95 96 97 98 99 100	1 2 3 4 5 6 7 8 9 10 11 12 13 14 15 16 17 18 19 20 21 22 23 24 25 26 27 28 29 30 31 32 33 34 35 36 37 38 39 40 41 42 43 44 45 46 47 48 49 50 51 52 53 54 55 56 57 58 59 60 61 62 63 64 65 66 67 68 69 70 71 72 73 74 75 76 77 78 79 80 81 82 83 84 85 86 87 88 89 90 91 92 93 94 95 96 97 98 99 100	1 2 3 4 5 6 7 8 9 10 11 12 13 14 15 16 17 18 19 20 21 22 23 24 25 26 27 28 29 30 31 32 33 34 35 36 37 38 39 40 41 42 43 44 45 46 47 48 49 50 51 52 53 54 55 56 57 58 59 60 61 62 63 64 65 66 67 68 69 70 71 72 73 74 75 76 77 78 79 80 81 82 83 84 85 86 87 88 89 90 91 92 93 94 95 96 97 98 99 100

- NOTE:
- S201: Speed selector switch (33.1/3 r.p.m.) in "ON" position (push condition)
 - S202: Speed selector switch (45 r.p.m.) in "OFF" position (no-push condition)
 - S203: Start/Stop switch in "OFF" position (no-push condition)
 - S301: Pitch lock switch in "ON" position (center position)
 - S401: Stylus-illuminator switch in "OFF" position.
 - S601: Power switch in "ON" position.
 - S602: Power source switch in "220-240V" position.
- The drive circuit IC voltage and wave form are not indicated in side the schematic diagram.
 - Indicated voltage value are the standard values for the unit measured by DC electronic circuit tester (high impedance) with the chassis taken as standard. Therefore, there may exist some errors in the voltage values, depending on the internal impedance of the DC circuit tester.
 - △ indicates that only parts specified by the manufacturer be used for safety.

REPLACEMENT PARTS LIST (Electrical)

- Notes:**
- Part numbers are indicated on most mechanical parts. Please use this number for parts orders.
 - △ indicates that only parts specified by manufacturer be used for safety.
 - SL-1200MK2 (XG) → [XG], SL-1200MK2 (XA) → [XA], SL-1200MK2 (XGB) → [XGB]
SL-1200MK2 (XAL) → [XAL], SL-1200MK2 (E) → [E]

Ref. No.	Part No.	Part Name & Description
INTEGRATED CIRCUITS		
IC101	AN6675	Integrated Circuit
IC201	AN6680	Integrated Circuit
IC301	AN6682	Integrated Circuit
IC302	SVITC4011BP	Integrated Circuit
TRANSISTORS		
Q1	2SD389A-Q	Transistor
Q2, 3, 202	2SD637	Transistor
Q201	2SC1846-R	Transistor
Q203	2SC1328-T	Transistor
DIODES		
D1	△ SVDS1RBA40	Rectifier
D2, 301	MA1051	Diode, Zener 5.1V
D204	MA162A	Diode
D201, 202	SVDSR-105C	Light Emitting Diode
D203~206	SVDEBR5505S	Light Emitting Diode
D301	SV DGL-9PG2	Light Emitting Diode
CRYSTAL		
X201	SVQU306115	Crystal, 4.19328MHz Oscillator
VARIABLE RESISTORS		
VR201	EVLS6AA00B54	Braking Adjustment (BRAKE), 50kΩ (B)
VR301	EVMH2GA00B53	Adjustment of Pitch Control ±0.6% (PITCH), 5kΩ (B)
VR302	EVLS6AA00B54	Pitch Adjustment (Gain) 50kΩ
VR303	EVBJ05C19ABE	Pitch Control Volume
SWITCHES		
S201	EVQP5R04K	Switch, Speed Selector (33 1/3 r.p.m.)
S202	EVQP5R04K	Switch, Speed Selector (45 r.p.m.)
S203	SFDS55GL13C	Switch, Start/Stop
S401	SFDS2MSL-4	Switch, Stylus-illuminator
S601	△ SFDS55GL13S	Switch, Power
S602	△ SFDSHXW01317	Switch, Power Source
LAMP		
PL1	SFDN172-01	Lamp, Stylus-illuminator
TRANSFORMER		
T1	△ SLTF5900	Power Transformer
FUSE		
F1	△ XBA2C025T1A	Fuse, T250 mA
F2	△ XBA2C10TRO	Fuse, T1A
RESISTORS		
R1	ERD25FJ662	Carbon, 5.6kΩ, 1/4W, ± 5%
R2	ERD25FJ682	Carbon, 6.8kΩ, 1/4W, ± 5%
R3	ERD25FJ272	Carbon, 2.7kΩ, 1/4W, ± 5%
R4	ERD25FJ561	Carbon, 560Ω, 1/4W, ± 5%
R5	ERD25FJ471	Carbon, 470Ω, 1/4W, ± 5%
R101	ERD25FJ103	Carbon, 10kΩ, 1/4W, ± 5%
R102	△ ERX1ANJ4R7	Metal Film, 4.7Ω, 1W, ± 5%
R103	ERD25FJ472	Carbon, 4.7kΩ, 1/4W, ± 5%
R104	ERD25FJ473	Carbon, 47kΩ, 1/4W, ± 5%
R105	ERD25FJ103	Carbon, 10kΩ, 1/4W, ± 5%
R106	ERD25FJ150	Carbon, 15Ω, 1/4W, ± 5%

Ref. No.	Part No.	Part Name & Description
R107	△ ERX1ANJ1R5	Metal Film, 1.5Ω, 1W, ± 5%
R108	ERD25FJ103	Carbon, 10kΩ, 1/4W, ± 5%
R109, 110	△ ERX1ANJ4R7	Metal Film, 4.7Ω, 1W, ± 5%
R201	△ ERG1ANJ561	Metal Oxide, 560Ω, 1W, ± 5%
R202	ERD25FJ103	Carbon, 10kΩ, 1/4W, ± 5%
R203	ERD25FJ470	Carbon, 47Ω, 1/4W, ± 5%
R204	ERD25FJ272	Carbon, 2.7kΩ, 1/4W, ± 5%
R205	ERD25TJ124	Carbon, 120kΩ, 1/4W, ± 5%
R206	ERD25TJ183	Carbon, 18kΩ, 1/4W, ± 5%
R207	ERD25TJ563	Carbon, 56kΩ, 1/4W, ± 5%
R208	ERD25TJ224	Carbon, 220kΩ, 1/4W, ± 5%
R209	ERD25TJ154	Carbon, 150kΩ, 1/4W, ± 5%
R210	ERD25TJ183	Carbon, 18kΩ, 1/4W, ± 5%
R211	ERD25FJ103	Carbon, 10kΩ, 1/4W, ± 5%
R212	ERD25FJ121	Carbon, 120Ω, 1/4W, ± 5%
R213	ERD25FJ122	Carbon, 1.2kΩ, 1/4W, ± 5%
R214	ERD25TJ223	Carbon, 22kΩ, 1/4W, ± 5%
R215	ERD25FJ472	Carbon, 4.7kΩ, 1/4W, ± 5%
R216	ERD25TJ154	Carbon, 150kΩ, 1/4W, ± 5%
R217	ERD25TJ223	Carbon, 22kΩ, 1/4W, ± 5%
R218	ERD25FJ102	Carbon, 1kΩ, 1/4W, ± 5%
R219	ERD25FJ332	Carbon, 3.3kΩ, 1/4W, ± 5%
R220	ERD25FJ221	Carbon, 220Ω, 1/4W, ± 5%
R221	ERD25FJ471	Carbon, 470Ω, 1/4W, ± 5%
R301	ERD25CKF3301	Metal Film, 3.3kΩ, 1/4W, ± 1%
R302	ERD25FJ471	Carbon, 470Ω, 1/4W, ± 5%
R303	ERD25FJ822	Carbon, 8.2kΩ, 1/4W, ± 5%
R304	ERD25FJ152	Carbon, 1.5kΩ, 1/4W, ± 5%
R306	ERD25TJ223	Carbon, 22kΩ, 1/4W, ± 5%
R601	ERD25FJ4R7	Carbon, 4.7Ω, 1/4W, ± 5%
CAPACITORS		
C1	ECEB1HS471	Electrolytic, 470μF, 50V
C2	ECEA1VS330	Electrolytic, 33μF, 35V
C3	ECEA1ES220	Electrolytic, 22μF, 25V
C101, 102	ECEA1VS330	Electrolytic, 33μF, 35V
C103	ECEA1VS330	Electrolytic, 33μF, 35V
C104, 105	ECQM1H104KZ	Polyester, 0.1μF, 50V, ±10%
C106, 107	ECQM1H104KZ	Polyester, 0.1μF, 50V, ±10%
C108	ECEA1ES101	Electrolytic, 100μF, 25V
C109, 110	ECQM1H104KZ	Polyester, 0.1μF, 50V, ±10%
C111	ECQM1H562KZ	Polyester, 0.0056μF, 50V, ±10%
C112	ECEA1JS4R7	Electrolytic, 4.7μF, 63V
C201	ECEA1CS330	Electrolytic, 33μF, 16V
C202, 203	ECEA50Z1	Electrolytic, 1μF, 50V
C204	ECQM1H473KZ	Polyester, 0.047μF, 50V, ±10%
C205	ECEA1AS221	Electrolytic, 220μF, 10V
C206	ECEA50Z1	Electrolytic, 1μF, 50V
C207	ECCD1H101K	Ceramic, 100pF, 50V, ±10%
C208	ECCD1H390K	Ceramic, 39pF, 50V, ±10%
C209	ECEA1ES101	Electrolytic, 100μF, 16V
C210	ECQM1H224KZ	Polyester, 0.22μF, 50V, ±10%
C211	ECQM1H473KZ	Polyester, 0.047μF, 50V, ±10%
C212	ECEA50Z3R3	Electrolytic, 3.3μF, 50V
C213	ECCD1H471K	Ceramic, 470pF, 50V, ±10%
C214	ECEA1ES101	Electrolytic, 100μF, 25V
C215	ECEA50Z1	Electrolytic, 1μF, 50V
C216	△ ECEA1ES470	Electrolytic, 47μF, 25V
C301, 302	ECQK1123FZ	Polyester, 0.012μF, 125V, ± 1%
C303	ECEA50Z1	Electrolytic, 1μF, 50V
C304	ECEA1HS100	Electrolytic, 10μF, 50V
C305	ECQM1H122KZ	Polyester, 0.0012μF, 50V, ±10%
C306	ECEA50Z1	Electrolytic, 1μF, 50V
C601	ECNC4A473M	Paper, 0.047μF, 400V, ±20%

■ TROUBLE SHOOTING

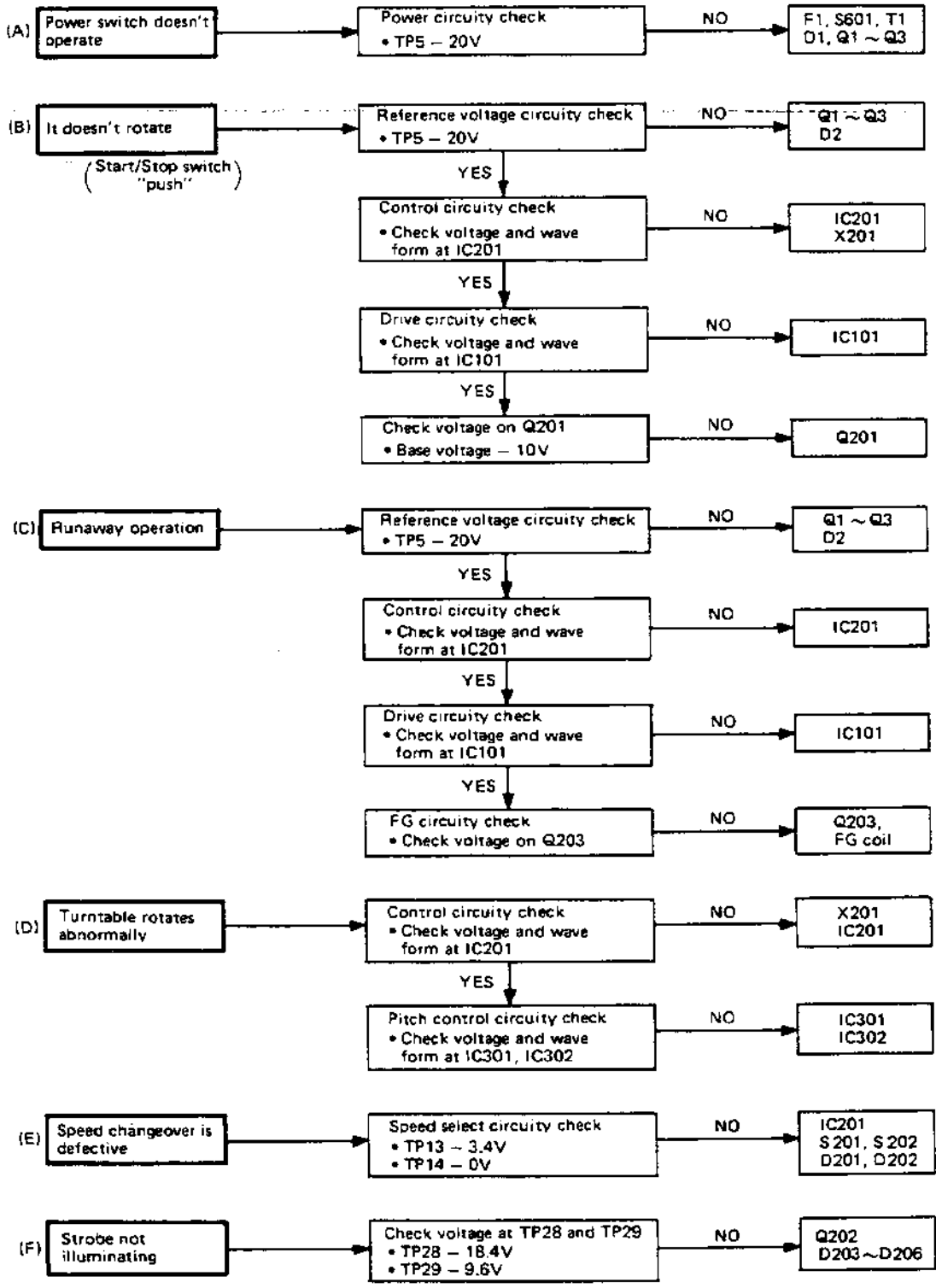

Printed Circuit Board

+ B line
Earth (Ground) lines

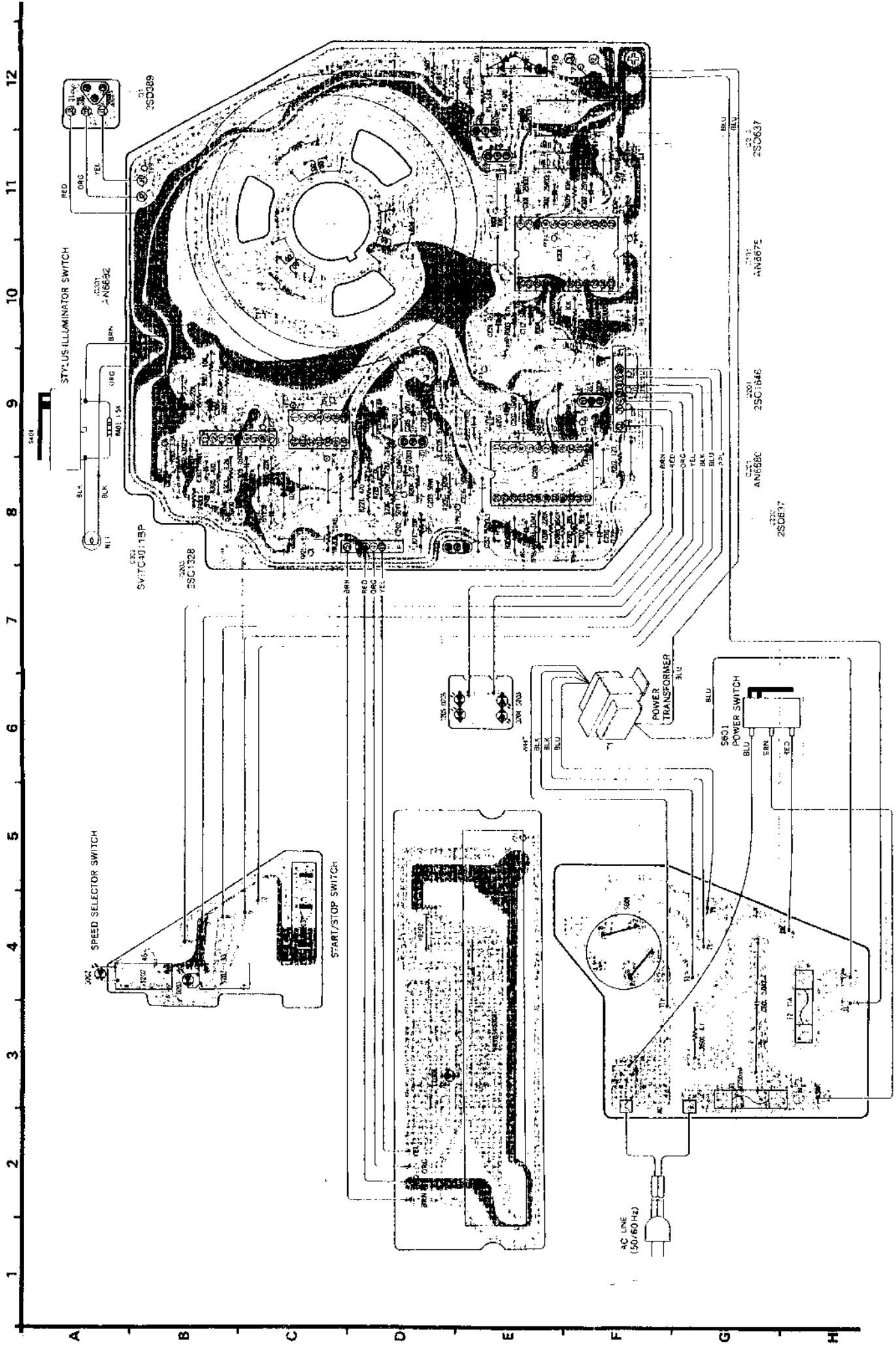

SL-1200MK2 SL-1200MK2

■ BLOCK DIAGRAM

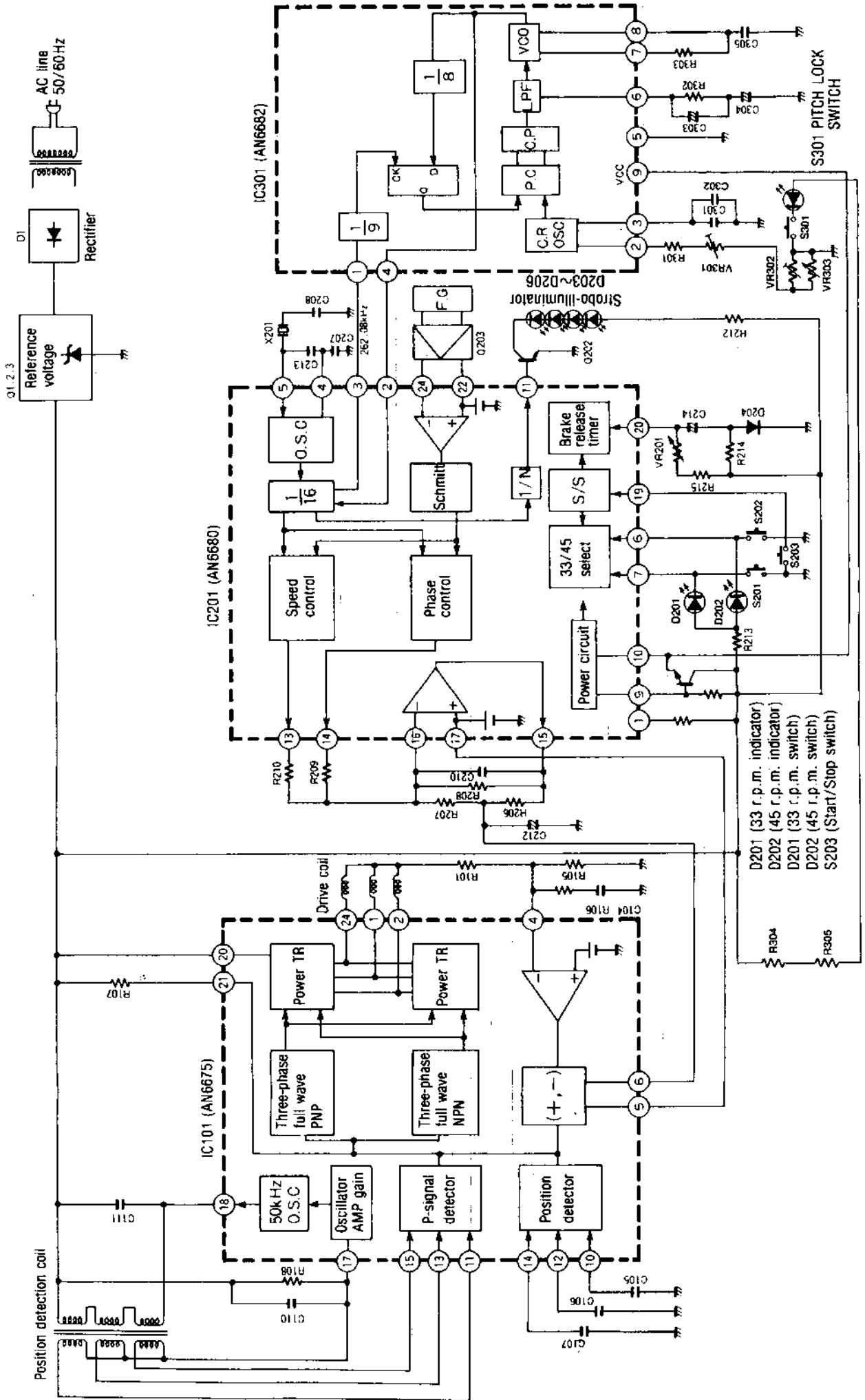

ADJUSTMENT (Electrical)

Notes: • Make the following adjustments after replacing parts such as IC's, transistors, diodes, etc.

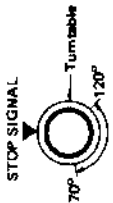

- Condition of the set.
 1. Power switch ON
 2. Pitch control Center position
 3. Speed selector switch 33-1/3 r.p.m.
- Instruments to be used
 1. Tester
 2. Frequency counter

Adjustment	Connection Points	Adjustment Point	Adjustment Method
A Adjustment of pitch control $\pm 0\%$ (PITCH)	Frequency counter ④ — TP27 ⊖ — GROUND	VR301	1. Pitch control switch to center position. 2. Adjust VR301 for 262.08 kHz ± 0.05 kHz of frequency.
B Adjustment of pitch control gain	Tester TP31 and TP32	VR302	Adjust VR302 for 2.7 k Ω ± 0.1 of resistance value
C Braking adjustment (BRAKE)	—	VR201	Adjust VR201 for complete stop within 120° ~ 270° after stop signal initiated. (Turntable becomes free a few seconds after stop) 





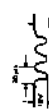
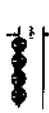

REFERENCE VOLTAGE AND WAVEFORM AT EACH IC

PIN

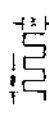

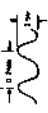
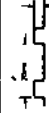

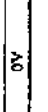
IC101 - A4065/3A

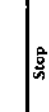
Start	Stop	Start	Stop	Start	Stop
① 2V	2V				
② 2V	2V		15V	③ Same as at right	
③ 0V	0V				
④ 5V	5V			④ 20V	20V
⑤ 5V	5V			⑤ 20V	20V
⑥ 6.6V	6.6V			⑥ 20V	20V
⑦ 0V	0V	15V	15V	⑦ 0.2V	0.2V
⑧ 5V	5V			⑧ 20V	20V
⑨ 0V	0V			⑨ 1.7V	1.7V
⑩ 15V	15V				
		0V	0V		
		15V	15V		

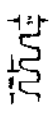
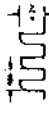

IC201 - A4N6680J

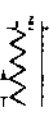
Start	Stop	Start	Stop	Start	Stop
① 2.5V	2.5V	④ 0V	0V	⑤ 5V	2.5V
② Same as at right		⑤ 9.8V	9.8V	⑥ 5V	5V
③ Same as at right		⑥ 10V	10V	⑦ 0V	0V
④ Same as at right		⑦ Same as at right		⑧ 7.5V	0V
⑤ Same as at right		⑧ 0V	0V	⑨ 0V	5V
⑥ 3.4V	3.4V	⑨ 0V	0V	⑩ 1.5V	0V
⑦ 0V	0V	⑩ 3V	3V	⑪ 3V	3V
⑧ Same as at right		⑪ Same as at right		⑫ 2.8V	2.8V
⑨ Same as at right		⑫ 8V	8V		
⑩ 3.4V	3.4V				
⑪ 0V	0V				

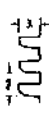

IC301 - A4N6682J

Start	Stop	Start	Stop	Start	Stop
① Same as at right		⑤ Same as at right		⑥ Same as at right	
② Same as at right		⑥ 0V	0V	⑦ 9V	9V
③ Same as at right		⑦ 3.9V	3.9V		
		⑧ Same as at right			

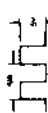
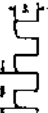
IC302 - 5V1TC-011BP

Start	Stop	Start	Stop	Start	Stop
① Same as at right		⑤ Same as at right		⑥ 5V	5V
② 5V	5V	⑥ 5V	5V	⑦ 5V	5V
③ Same as at right		⑦ 0V	0V	⑧ 0.6V	0.6V
④ 5V	5V	⑧ Same as at right		⑨ 0.6V	0.6V
				⑩ 5V	5V

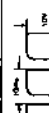
IC202 - 750637

Start	Stop	Start	Stop
E 0V	0V		
C Same as at right			
B Same as at right			

EXPLODED VIEWS

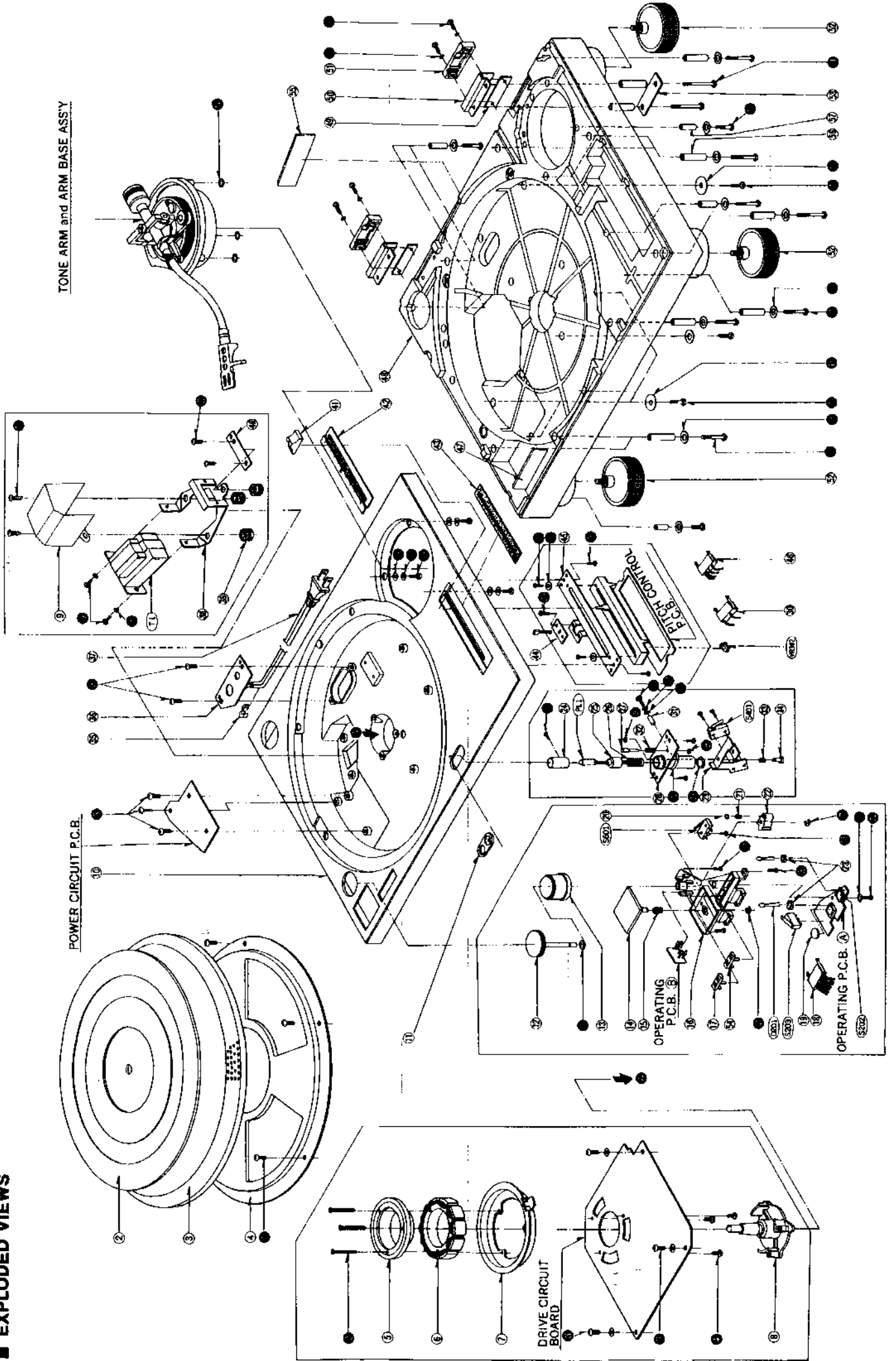

REPLACEMENT PARTS LIST (Mechanical)

- Notes: 1. Part numbers are indicated on most mechanical parts.
 Please use this number for parts orders.
 2. Δ indicates that only parts specified by manufacturer be used for safety.
 3. SL-1200MK2 (XG) \rightarrow [XG], SL-1200MK2 (XA) \rightarrow [XA], SL-1200MK2 (XB) \rightarrow [XB]
 SL-1200MK2 (XAL) \rightarrow [XAL], SL-1200MK2 (E) \rightarrow [E]

Ref. No.	Part No.	Part Name & Description	Ref. No.	Part No.	Part Name & Description
CABINET and CHASSIS PARTS					
1	SFAD122-01A	Dust Cover	74	SF2B12201K	Plate, Position Fix
2	SF1G122-01	Turntable Mat	75	SFEL02B-01	Phono Cord
3	SF1E122-01	Turntable	76	SFEL02B-01E	Ground Wire
4	SFUM122-05	Cover, Turntable	77	SFPR12201K	Arm Rest
5	SFUM122-05A	Cover, Stair Frame Assy	78	SFPCD12201K	Arm Base
6	SFUM122-05A	Cover, Stair Frame Assy	79	SFPRB12201S	Ring, Arm Base Operation
7	SFUM122-01E	Spring, Start/Stop Knob	80	SFPA12201	Bracket, Arm Base
8	SFUM122-01A	Spring, Start/Stop Knob	81	SFPA12206	Knob, Annunciate Force Control
9	SFUM122-01A	Spring, Start/Stop Knob	82	SFGR122-01	Cap, Rubber
10	SFAC122-01	Cabinet	SCREWS, WASHERS and CIRCLIPS		
11	SFUM122-04	Ornament, Stylus Illuminator	●	XTM12BZFZ	Screw
12	SF K122-01	Knob, Power Switch	●	XTM12B-02	Screw
13	SF K122-01E	Knob, Power Switch	●	XTM12A-08	Screw
14	SF K122-01E	Knob, Power Switch	●	XTM12A-08	Screw
15	SF K122-06	Knob, Start/Stop Switch	●	XTM12A-10B	Screw
16	SFQA122-01	Spring, Start/Stop Knob	●	XW12B-01	Washer
17	SFUM122-01E	Base, Operation	●	XW12B-10	Washer
18	SFUM122-01E	Knob, Speed Selector (33-173 r.p.m.)	●	SFPEW1203	Washer
19	SFUM122-02E	Knob, Rubber Isolated Selector	●	SFPEW1205	Washer
20	SFUM122-01	Ball, Switch Cam	●	SFAG122-01	Screw
21	SFQA520-01	Spring, Switch Cam	●	XTM12A-08ZFZ	Screw
22	SFUM122-03	Cam, Switch	●	XN12A-10BVS	Screw
23	SFUM122-03	Cam, Switch	●	XW12B-12FZ	Washer
24	SF K122-01	Knob, LED	●	XTM12A-08ZFZ	Screw
25	SF X8122-02	Cover, Lamp	●	SF XW122-01	Washer
26	SFQA122-01	Box, Drive	●	XW12B-10	Washer
27	SFQA122-01	Spring, Drive Box	●	SFPEW1203	Washer
28	SFUM122-02E	Pin, Lock Latch	●	SFPEW1205	Washer
29	SFUM122-02E	Bracket, Stylus Illuminator	●	SFAG122-01	Screw
30	SFUM122-03	Plate, Lock Operation	●	XTM12A-08ZFZ	Screw
31	SFUM122-03E	Connector, 3PIN	●	XTM12A-10B	Screw
32	SFQA520-01	Pin, Guide	●	XTM12A-10B	Screw
33	SFQA520-01	Spring, Lock Canceler Pin	●	XSN12A-3FY	Screw
34	SFQA520-01	Spring, Lock Operating Plate M'g	●	XN12A-14S	Screw
35	SFQA520-01	Spring, Lock Operating Plate M'g	●	SF XW122-04	Washer
36	SFQA520-01	Clamper, AC Cord	●	XUB12AFT	Circlip
37	SFQA520-01	Clamper, AC Cord	●	SF U2122-05	Circlip
38	SFQA520-01	Strainer, AC Cord	●	XTM12A-08	Screw
39	SFQA520-01	Strainer, AC Cord	●	XN12A-14S	Screw
40	SFQA520-01	Strainer, AC Cord	●	XW12B-10	Washer
41	SFQA520-01	Strainer, AC Cord	●	XW12B-12FZ	Washer
42	SFQA520-01	Strainer, AC Cord	●	XW12B-10	Washer
43	SFQA520-01	Strainer, AC Cord	●	XW12B-12FZ	Washer
44	SFQA520-01	Strainer, AC Cord	●	XW12B-10	Washer
45	SFQA520-01	Strainer, AC Cord	●	XW12B-12FZ	Washer
46	SFQA520-01	Strainer, AC Cord	●	XW12B-10	Washer
47	SFQA520-01	Strainer, AC Cord	●	XW12B-12FZ	Washer
48	SFQA520-01	Strainer, AC Cord	●	XW12B-10	Washer
49	SFQA520-01	Strainer, AC Cord	●	XW12B-12FZ	Washer
50	SFQA520-01	Strainer, AC Cord	●	XW12B-10	Washer
51	SFQA520-01	Strainer, AC Cord	●	XW12B-12FZ	Washer
52	SFQA520-01	Strainer, AC Cord	●	XW12B-10	Washer
53	SFQA520-01	Strainer, AC Cord	●	XW12B-12FZ	Washer
54	SFQA520-01	Strainer, AC Cord	●	XW12B-10	Washer
55	SFQA520-01	Strainer, AC Cord	●	XW12B-12FZ	Washer
56	SFQA520-01	Strainer, AC Cord	●	XW12B-10	Washer
57	SFQA520-01	Strainer, AC Cord	●	XW12B-12FZ	Washer
58	SFQA520-01	Strainer, AC Cord	●	XW12B-10	Washer
ACCESSORIES					
A1	SFNU122X01	Instruction Book	A1	SFNU122X01	Instruction Book
A2	SFWE120	Adaptor, 45 r.p.m.	A2	SFWE120	Adaptor, 45 r.p.m.
A3	SFPE120	Nut, Cartridge	A3	SFPE120	Nut, Cartridge
A4	SFPE120	Washer, Cartridge	A4	SFPE120	Washer, Cartridge
A5	SFPE120	Screw, Cartridge	A5	SFPE120	Screw, Cartridge
A6	SFPE120	Screw, Cartridge	A6	SFPE120	Screw, Cartridge
A7	SFPE120	Sheet, Cartridge	A7	SFPE120	Sheet, Cartridge
A8	SFPE120	Page, 2 PIN	A8	SFPE120	Page, 2 PIN
PACKINGS					
P1	SFPH122M01	Cartron	P1	SFPH122M01	Cartron
P2	SFPH122-01	Pad, Front	P2	SFPH122-01	Pad, Front
P3	SFPH122-02	Pad, Rear	P3	SFPH122-02	Pad, Rear
P4	SFPH122-01	Pad, Top	P4	SFPH122-01	Pad, Top
P5	SFPH122-02	Pad, (A), Turntable	P5	SFPH122-02	Pad, (A), Turntable
P6	SFPH122-03	Pad, (B), Turntable	P6	SFPH122-03	Pad, (B), Turntable
P7	SFPH122-04	Polystyrene Cover, Turntable Unit and Dust Cover	P7	SFPH122-04	Polystyrene Cover, Turntable Unit and Dust Cover
P8	SFPH122-05	Polystyrene Cover, Turntable	P8	SFPH122-05	Polystyrene Cover, Turntable
TONE ARM and ARM BASE					
B1	SFAC12201K	Head Shell	B1	SFAC12201K	Head Shell
B2	SFUM12201K	One Arm Assy	B2	SFUM12201K	One Arm Assy
B3	SFUM12201K	Balance Height Assy	B3	SFUM12201K	Balance Height Assy
B4	SFPR12201K	Knob, Arm Base Lock	B4	SFPR12201K	Knob, Arm Base Lock
B5	SFQA12201K	Spring, Lift Assy	B5	SFQA12201K	Spring, Lift Assy
B6	SFQA12201K	Knob, Arm Lift	B6	SFQA12201K	Knob, Arm Lift
B7	SFQA12201K	Oil Damper	B7	SFQA12201K	Oil Damper
B8	SFQA12201K	Plate, Arm Base Cover	B8	SFQA12201K	Plate, Arm Base Cover
B9	SFUM12201K	Spacer, Phono Cord	B9	SFUM12201K	Spacer, Phono Cord
B10	SFPA12201K	Clamper, Phono Cord	B10	SFPA12201K	Clamper, Phono Cord
B11	SFPA12201K	Tone Arm Flang Plate Assy	B11	SFPA12201K	Tone Arm Flang Plate Assy

EXPLODED VIEWS

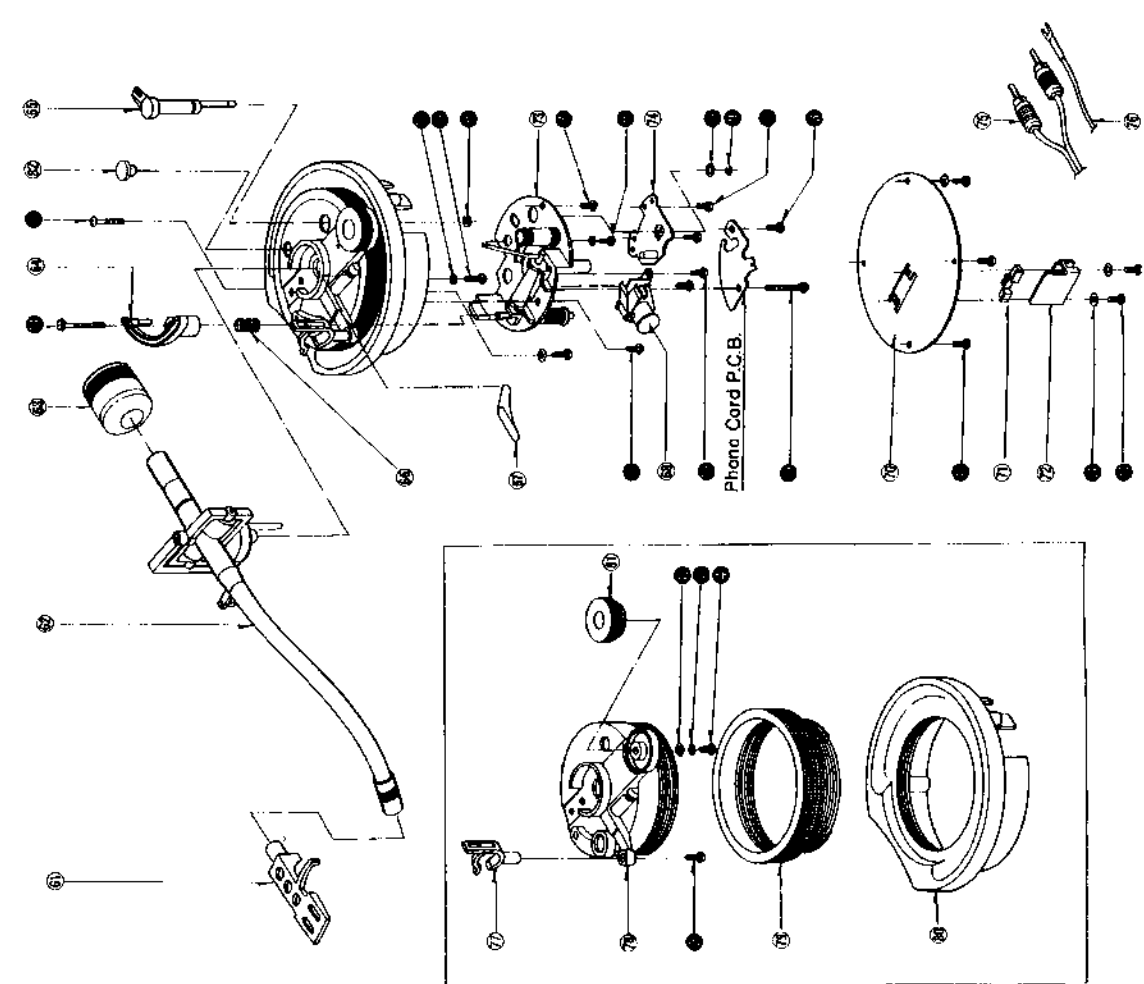

■ FEATURES

Total quartz locked continuous pitch adjustment ±8%

Quartz-phase-locked control means almost perfect accuracy of turntable rotation. But with most quartz turntables, this accurate control circuit must be cut out when the pitch control is employed. With the SL-1200MK2, however, pitch is variable continuously (analogically) by up to ±8% under total quartz-locked control. The pitch is controlled with a large sliding lever, located to the right of the turntable platter. Four lines of platter markings are also provided indicating +6%, +3.3%, 0% (exact rated speed) and -3.3% change from rated speed.

Aluminum diecast cabinet and special heavy rubber base material provide acoustic isolation

The effects of external vibrations are dramatically reduced in the turntable by this new turntable construction. The turntable base is precision-made aluminum diecast. And the underside of the main base is made of a heavy rubber material (special one-piece molding) which has excellent vibration resistance and absorbing characteristics. The turntable platter is also vibration-damped with specially fabricat rubber matting in the underside along with the thick turntable sheet (rubber mat). Four large-size insulating feet also help to absorb unwanted vibrations. These features make SL-1200MK2 ideal for use with extra-high sound pressure levels.

High torque for fast starts

The integral rotor/platter motor delivers 1.5kg-cm (1.3lb-in) starting torque. This high torque gives very quick starts enabling the platter to reach 33-1/3 rpm within 0.7 s. (a quarter of a turn). This is a big advantage in many professional applications where fast cueing is a necessity.

Stylus illuminator for low-light conditions

You'll appreciate the stylus illuminator when you are using the turntable under low-light conditions. The illuminator can be hidden in the turntable base, should you need it, simply push a button and it will pop up gently and cast a beam of light across the disc in the area traversed by the tonearm.

You can then clearly see the spaces between the selections on the record, and cue the arm exactly where you want it. The illuminator can then be pushed back down into the base.

High sensitivity, low mass, gimbal suspension tonearm

The highly sensitive tonearm features a genuine gimbal suspension, the rotational center of which is precisely defined at one point. Bearings are finished to a tolerance of ±0.5 microns. This and the extra-closeness of pivot center to the bearings, result in the minimal friction of 7 mg (0.007 g) for both horizontal and vertical movement. Add to this the low 12-gram effective tonearm mass (including headshell, without cartridge) and you have a tonearm compatible with the wide range of compliances found in today's cartridges. If you choose a popular high compliance MM cartridge, the low range resonance frequency will appear in the correct area to avoid warp frequencies of records, but without entering the low end of the audio spectrum. This tonearm is provided with a computer designed, light-weight, high-rigidity headshell made of single-piece diecast aluminum to resist partial vibration. The universal design allows headshell interchangeability. Contacts are gold-plated.

Helicoid tonearm height adjustment

Arm height is adjustable within a range of 6 mm to accommodate varying cartridge dimensions. Adjustments are done with a precision-made helicoid.

Other fine features

- Quick stops are achieved with a fully electronic braking system.
- A strobe illuminator is provided. The stroboscope is controlled by the extremely stable quartz oscillator, rather than potentially unstable AC line frequency.
- Power on/off control built into strobe illuminator for ease-of-operation.
- Soft-touch start-stop switch allowing precision control capability without the annoyance of accidental operation.
- Technics integral rotor/platter motor construction with full cycle detection FG.

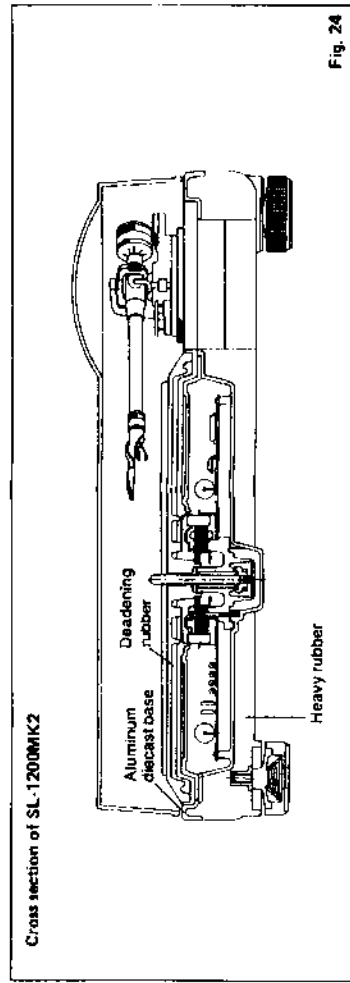

Cross section of SL-1200MK2

Fig. 24

— NOTE —

Panasonic Technics

Panasonic Service Dokumentations-Center

**Schaltungsdienst
Lange o.H.G.**

Verlag Technischer Druckschriften

Postfach 47 06 53
D-12315 Berlin

Telefon 0 30 / 723 81-3
Telefax 0 30 / 723 81 500